

B-Nimis MC-I/O EtherCAT® I/O Modules



Copyright © Berghof Automation GmbH

Reproduction and duplication of this document and utilisation and communication of its content is prohibited, unless with our express permission. All rights reserved. Damages will be payable in case of infringement.

Disclaimer

The content of this publication was checked for compliance with the hardware and software described. However, discrepancies may arise, therefore no liability is assumed regarding complete compliance. The information in this document will be checked regularly and all necessary corrections will be included in subsequent editions. Suggestions for improvements are always welcome.

Subject to technical changes.

Trademarks

- CANtrol® and CANtrol®- dialog are registered trademarks of Berghof Automation GmbH
- Microsoft®, Windows® and the Windows® Logo are registered trademarks of Microsoft Corporation in the USA and other countries.
- EtherCAT® is a registered trademark and patented technology, licensed from Beckhoff Automation GmbH, Germany.
- CiA® and CANopen® are registered community trademarks of CAN in Automation e.V.

All rights reserved by the individual copyright holders.

General Information on this Manual

This equipment manual contains product-specific information valid at the time of publication.

This equipment manual is only complete in conjunction with the product-related hardware and software user manuals required for the individual application.

You can reach us at:

Berghof Automation GmbH

Arbachtalstrasse 26

72800 Eningen

Germany

T +49.7121.894-0

F +49.7121.894-100

e-mail: controls@berghof.com

www.berghof-automation.com

Berghof Automation GmbH works in accordance with DIN EN ISO 9001:2000.

Update

Version	Date	Subject
1.01	16.10.2012	First Version
1.1	09.11.2012	Update of document title and the trademarks
1.2	04.04.2013	Transition in new CD Update of chapter 'Temperature modules' with module AI8-PT/Ni100 Update of 'Technical data' in all chapters
1.3	25.07.2013	Update of tables 'Analogue values current' and 'Analogue values voltage' Update of table 'Analogue outputs' in chapter 'Analogue outputs voltage / current AO4-U/I', section 'Function'
1.4	20.06.2017	New corporate name ,Berghof Automation GmbH' New EMC Directive Addition of section ,Installation' in chapter ,System description EtherCAT I/O Modules' Addition of chapter ,System description EtherCAT I/O Modules' with section ,Technical data (overview)' Addition of new module MC-I/O DO8 Relais NO 24V Addition of new module MC-I/O DO8 Relais NO 230VAC Addition of new module MC-I/O BK DI16/DO16 1MS/0,5A Update of section ,Analogue outputs voltage / current AO4-U/I', ,Technical data' Update of section ,Technical data' in chapter ,Counter modules' Update of flash code of EtherCAT LED of all modules Update of ,Technical data' in all chapters Chapter ,Communication modules' is dropped Update of chapter ,Annex' UL certification
1.5	24.11.2017	New title page Updating label of various modules Updating various graphics Update of section ,Counters with analogues outputs COUNTER/POS2 5V', ,Technical data' Addition of section ,Overview MC-I/O Modules' in chapter ,System description EtherCAT I/O Modules' Addition of new module MC-I/O AI4-I 12BIT CoE Addition of new module MC-I/O AI8-I 12BIT CoE Addition of new module MC-I/O AI4/8-U 13BIT CoE Addition of new module MC-I/O AI8/16-U 13BIT CoE Addition of new module MC-I/O AI4-PT/NI/THERMO 16BIT CoE Addition of new module MC-I/O AI8-PT/NI/THERMO 16BIT CoE Deletion of module MC-I/O COUNTER2 5V

Version	Date	Subject
1.6	13.02.2018	Update of section ,Technical data' in chapter ,Digital modules with integrated bus coupler' Update of section ,Overview MC-I/O Modules' in chapter ,System description EtherCAT I/O Modules' Addition of new module MC-I/O AO4-U/I 16BIT CoE
1.7	23.02.2022	revised
1.8		internal
1.9	30.09.2022	Replacement "CANtrol" with "B-Nimis" Replacement "E-I/O" with "MC-I/O" Update section ,The Berghof Automation platform' Update section ,List of figures' New figure in chapter ,MC-I/O – B-Nimis EtherCAT I/O-System' New figure in section ,Mechanical design' New figure in section ,EXTENDER 2 PORT' Update of the figures of the MC-I/O Modules with order number S-0XXXXXXXX-XXXX Update of the order numbers S-02020201-XXXX of the plug-in connectors New figures in section ,Analogue inputs for voltage measurement AI4/8-U 13BIT CoE' Addition of new module MC-I/O CAN S-01030203-0500

Contents

- 1. GENERAL INFORMATION 10**
- 1.1. About This Manual 10
- 1.2. Hazard Categories and Terminology 11
- 1.3. Conformity Declaration..... 11
- 1.4. Qualified Personnel..... 12
- 1.5. Due Diligence..... 12
- 1.5.1. Working on the controller module..... 12
- 1.6. Use as Prescribed 13

- 2. INTRODUCTION ETHERCAT I/O MODULES..... 14**
- 2.1. EtherCAT - Ethernet Control Automation Technology 14
- 2.2. The Berghof Automation platform 14
- 2.3. B-Nimis MC-I/O EtherCAT I/O-System 15
- 2.4. Electromagnetic compatibility 16
- 2.4.1. Definition 16
- 2.4.2. Interference emission 16
- 2.4.3. General notes on installation 16
- 2.4.4. Electrical immission safeguard 16
- 2.4.5. Cable routing and wiring..... 17
- 2.4.6. Location of installation 17
- 2.4.7. Particular sources of interference..... 17

- 3. SYSTEM DESCRIPTION ETHERCAT I/O MODULES 18**
- 3.1. Mechanical design 18
- 3.1.1. Earth..... 19
- 3.1.2. Installation 20
- Installation order within an MC-I/O system..... 20
- 3.2. System power supply 22
- 3.2.1. General 22
- 3.2.2. Bus coupler 22
- 3.2.3. I/O Modules 22
- 3.3. Status LEDs 23
- 3.3.1. "EtherCAT" LED 23
- 3.3.2. "In" LED, "Out" LED 23
- 3.3.3. "I/O" LED 23
- 3.3.4. "Power" LED..... 23
- 3.4. Technical data (overview)..... 24
- 3.5. MC-I/O Modules (overview) 25

- 4. BUS COUPLER 26**
- 4.1. Terminals 26
- 4.2. Status LEDs 26

4.3.	Function	27
4.4.	Technical data	28
5.	DIGITAL MODULES WITH INTEGRATED BUS COUPLER	29
5.1.	Terminals	29
5.2.	Status LEDs	29
5.3.	Function	31
5.4.	Technical data	32
6.	DIGITAL MODULES	33
6.1.	Digital in- and outputs DI16 / DO16	33
6.1.1.	Terminals	33
6.1.2.	Status LEDs	33
6.1.3.	Function	35
6.1.4.	Technical data	35
6.2.	Digital inputs DI32	36
6.2.1.	Terminals	36
6.2.2.	Status LEDs	36
6.2.3.	Function	37
6.2.4.	Technical data	37
6.3.	Digital inputs DI16	38
6.3.1.	Terminals	38
6.3.2.	Status LEDs	38
6.3.3.	Function	39
6.3.4.	Technical data	39
6.4.	Digital outputs DO16	40
6.4.1.	Terminals	40
6.4.2.	Status LEDs	40
6.4.3.	Function	41
6.4.4.	Technical data	42
6.5.	Digital outputs DO8 RELAIS NO 24V	43
6.5.1.	Terminals	43
6.5.2.	Status LEDs	43
6.5.3.	Function	44
6.5.4.	Technical data	45
6.6.	Digital outputs DO8 RELAIS NO 230VAC	46
6.6.1.	Terminals	46
6.6.2.	Status LEDs	46
6.6.3.	Function	47
6.6.4.	Technical data	48
7.	ANALOGUE MODULES	49
7.1.	Analogue inputs for current measurement AI4-I	49
7.1.1.	Terminals	49
7.1.2.	Status LEDs	49
7.1.3.	Function	50
7.1.4.	Technical data	55

7.2. Analogue inputs for current measurement AI8-I	56
7.2.1. Terminals	56
7.2.2. Status LEDs	56
7.2.3. Function	57
7.2.4. Technical data	63
7.3. Analogue inputs for current measurement AI4-I 12BIT CoE	64
7.3.1. Terminals	64
7.3.2. Status LEDs	64
7.3.3. Function	65
7.3.4. Technical data	72
7.4. Analogue inputs for current measurement AI8-I 12BIT CoE	73
7.4.1. Terminals	73
7.4.2. Status LEDs	73
7.4.3. Function	74
7.4.4. Technical data	81
7.5. Analogue inputs for voltage measurement AI4/8-U	82
7.5.1. Terminals	82
7.5.2. Status LEDs	83
7.5.3. Function	84
7.5.4. Technical data	87
7.6. Analogue inputs for voltage measurement AI4/8-U 13BIT CoE	88
7.6.1. Terminals	88
7.6.2. Status LEDs	88
7.6.3. Function	89
7.6.4. Technical data	96
7.7. Analogue inputs for voltage measurement AI8/16-U 13BIT CoE	97
7.7.1. Terminals	97
7.7.2. Status LEDs	97
7.7.3. Function	98
7.7.4. Technical data	106
7.8. Analogue outputs voltage / current AO4-U/I	107
7.8.1. Terminals	107
7.8.2. Status LEDs	107
7.8.3. Function	109
7.8.4. Technical data	112
7.9. Analogue outputs voltage / current AO4-U/I 16BIT CoE	113
7.9.1. Terminals	113
7.9.2. Status LEDs	113
7.9.3. Function	115
7.9.4. Technical data	121
8. TEMPERATURE MODULES	122
8.1. Analogue temperature inputs AI4-PT/NI100, AI4-PT/NI1000	122
8.1.1. Terminals	122
8.1.2. Status LEDs	122
8.1.3. Function	123
8.1.4. Technical data AI4-PT/NI100	127
8.1.5. Technical data AI4-PT/NI1000	128

8.2.	Analogue temperature inputs AI8-PT/NI100	129
8.2.1.	Terminals	129
8.2.2.	Status LEDs	129
8.2.3.	Function	130
8.2.4.	Technical data AI8-PT/NI100	134
8.3.	Analogue temperature inputs AI4-THERMO 16BIT	135
8.3.1.	Terminals	135
8.3.2.	Status LEDs	135
8.3.3.	Function	136
8.3.4.	Technical data	139
8.4.	Analogue temperature inputs AI4-PT/NI/THERMO 16BIT CoE	140
8.4.1.	Terminals	140
8.4.2.	Status LEDs	140
	Function	142
8.4.3.	Technical data	149
8.5.	Analogue temperature inputs AI8-PT/NI/THERMO 16BIT CoE	151
8.5.1.	Terminals	151
8.5.2.	Status LEDs	151
8.5.3.	Function	153
8.5.4.	Technical data	163
9.	COUNTER MODULES	165
9.1.	Counters with analogues outputs COUNTER/POS12 5V	165
9.1.1.	Terminals	165
9.1.2.	Status LEDs	166
9.1.3.	Function	167
9.1.4.	Controlling and watching the entire module	168
9.1.5.	Controlling / Watching Counter 1	169
9.1.6.	Counter values of Zähler 1 (Counter 1)	172
9.1.7.	Digital I/Os.....	173
9.1.8.	Analogue outputs (COUNTER/POS12 5V only)	177
9.1.9.	Examples	178
9.1.10.	Technical data	182
10.	INTERFACE AND COMMUNICATION MODULES	184
10.1.	Communication module CAN	184
10.1.1.	Terminals	184
10.1.2.	Status LEDs	185
10.1.3.	Function	186
10.1.4.	Technical data	200
11.	EXTENDER	201
11.1.	EXTENDER 2 PORT	201
11.1.1.	Terminals	201
11.1.2.	Status LEDs	202
11.1.3.	Function	202
11.1.4.	Technical data	203
12.	SUPPLEMENT	204

12.1. POTENTIALVERTEILER 2x16 (Potential distributor)	204
12.1.1. Terminals	204
12.1.2. Status LEDs	204
12.1.3. Function	204
12.1.4. Technical data	205
12.2. SHIELD CONNECTION CLAMP (Shield connection terminal block)	205
12.2.1. Terminals	205
12.2.2. Function	206
12.2.3. Technical data	206
13. ANNEX	207
13.1. Environmental Protection	207
13.1.1. Emission.....	207
13.1.2. Disposal	207
13.2. Maintenance/Upkeep	207
13.3. Repairs/Service	207
13.3.1. Warranty.....	207
13.4. Product identification	208
Product identification descriptions (example)	208
13.5. Addresses and Bibliography / Standards	209
13.5.1. Addresses	209
13.5.2. Bibliography / Standards	210
13.6. List of figures	211

1. General Information

Documentation

This equipment manual is intended for qualified personnel and contains information regarding mounting, installation, commissioning and maintenance. The information contained in this manual is subject to change without prior notice.

1.1. About This Manual

This equipment manual is an integral part of the product. Make sure the equipment manual is always available near the product's point-of-employment. The manual contains information about the following topics:

- Areas of application;
- Safety;
- Mechanical construction;
- Electrical construction;
- Connections;
- Commissioning;
- Care and maintenance;
- Decommissioning;
- Disposal.

1.2. Hazard Categories and Terminology

The indications described below are used in connection with safety instructions you will need to observe for your own personal safety and the avoidance of damage to property.

These instructions are emphasised by bordering and/or shading and a bold-printed indication, their meaning being as follows:

DANGER

Immediate danger

Failure to observe the information indicated by this warning will result in death, serious injury or extensive property damage

WARNING

Potential danger

Failure to observe the information indicated by this warning may result in death, serious injury or extensive property damage

CAUTION

Danger

Failure to observe the information indicated by this warning may result in injury or property damage

NOTE

No hazard

Information indicated in this manner provides additional notes concerning the product

1.3. Conformity Declaration

The EtherCAT I/O Modules comply with and make allowance for the following directives and standards

- **EMC Directive 2014/30/EU**
- **RoHS-2 – Directive 2011/65/EU**
- **IEC 61131-2:2007** Programmable controllers
Part 2: Equipment requirements and tests
- **UL 508:2013-10** Industrial Control Equipment
17th Edition / 1999-01-28

1.4. Qualified Personnel

Only qualified personnel may install, operate and maintain the EtherCAT I/O Modules.

Within the context of this documentation and the safety information it contains, qualified personnel constitutes trained specialists who have the authority to mount, install, commission, ground and identify equipment, systems and power circuits in accordance with the standards of safety technology, and who are familiar with the safety concepts of automation technology.

1.5. Due Diligence

The operator, or the processor (OEM) must ensure that

- the EtherCAT I/O Modules are only used for the purpose for which they are intended;
- the EtherCAT I/O Modules are only operated in impeccable full working order;
- the user manual is always available in full and in a legible condition;
- only specialists with sufficient qualification and authorisation mount, install, commission and maintain the controller module;
- these specialists are regularly instructed in all relevant questions of occupational health and safety and environmental protection and that they also know the contents of the user manual and especially of the safety notes therein;
- the device markings, identifications, safety and warning notes attached to the EtherCAT I/O Modules are not removed and are always kept in a legible state;
- the national and international regulations for controlling machines and systems which apply at the relevant usage site are observed;
- the relevant information about the EtherCAT I/O Modules and their application and operation is always available to the users

1.5.1. Working on the controller module

Before carrying out work on the EtherCAT I/O Modules you must always

- first ensure that the controller and the system are in a secure state;
- only then switch off the controller and the system and
- only now disconnect the EtherCAT I/O Modules from the system.

1.6. Use as Prescribed

This is a modular automation system based on the CANbus, intended for industrial control applications within the medium to high performance range.

The automation system is designed for use within Overvoltage Category I (IEC 364-4-443) for the controlling and regulating of machinery and industrial processes in low-voltage installations in accordance with the following general parameters:

- maximum rated supply voltage of 1,000 VAC (50/60 Hz) or 1,500 VDC;
- for use in maximum category 2 pollution environment (EN 60950);
- for use up to a maximum altitude of 2,000 m above msn;
- max. ambient temperature inside and outside the control cabinet is within the technical specifications (see section "Technical data")

Qualified project planning and design, proper transport, storage, installation, use and careful maintenance are essential to the flawless and safe operation of the automation system.

The automation system may only be used within the scope of the data and applications specified in the present documentation and associated user manuals.

The automation system is to be used only as follows

- as prescribed,
- in technically flawless condition,
- without arbitrary or unauthorized changes and
- exclusively by qualified users

The regulations of the German professional and trade associations, the German technical supervisory board (TÜV), the VDE (Association of German electricians) or other corresponding national bodies are to be observed.

Safety-oriented (fail-safe) systems

Particular measures are required in connection with the use of PLCs in safety-oriented systems. If a PLC is to be used in a safety-oriented system, the user ought to seek the full advice of the PLC manufacturer in addition to observing any standards or guidelines on safety installations which may be available.

WARNING

As with any electronic control system, the failure of particular components may result in uncontrolled and/or unpredictable operation.

All types of failure and the associated fuse systems are to be taken into account at system level. The advice of the PLC manufacturer should be sought if necessary.

2. Introduction EtherCAT I/O Modules

2.1. EtherCAT - Ethernet Control Automation Technology

EtherCAT is one of the most powerful Ethernet-based fieldbus systems. EtherCAT puts up the top speed mark, and its flexible topology and simple configuration make it the perfect means of controlling extremely fast processes.

Because of its high performance, the simple wiring and its open protocol support, EtherCAT is often used as a fast motion control and I/O bus driven by an industrial PC or in conjunction with control technology on a smaller scale. EtherCAT moves beyond the limits of conventional fieldbus systems. Its interconnections between the controller at one end and both the I/O modules and drives at the other are as fast as those of a backplane bus. EtherCAT controllers thus nearly act like centralized control systems, overcoming the issue of bus transfer times that conventional fieldbus systems are burdened with.

2.2. The Berghof Automation platform

The automation platforms B-Nimis, B-Fortis and B-Primis have been specifically engineered with applications near to the machine in mind. Berghof provides flexible automation solutions including hardware and software PLCs based around industrial PCs, remote I/Os, PLCs with / without display and decentralized drives. EtherCAT, PROFINET, Bacnet, KNX, Ethernet/IP, Modbus and CANopen are supported for networking. Berghof controllers include an EtherCAT master in the standard and are programmable with CODESYS V3.5.

2.3. B-Nimis MC-I/O EtherCAT I/O-System

B-Nimis MC-I/O is a system of I/O modules for connecting the process signals to an EtherCAT network. B-Nimis MC-I/O consists of the MC-I/O bus coupler and a range of I/O modules. The B-Nimis MC-I/O bus coupler converts the physical transfer technology (twisted pair) to LVDS (E-bus) and generates the system voltages required by the LVDS modules. The standard 100 Base Tx lines used for office network communications connect to the one side, the B-Nimis MC-I/O Modules for the process signals connect to the other. This is how the Ethernet EtherCAT protocol is retained right through to the last I/O module. At the end of the modular device, the connection between the forward and return lines is automatically closed, the effect being that another 100 Base Tx line can be plugged in to connect the next EtherCAT unit to the second bus coupler port..

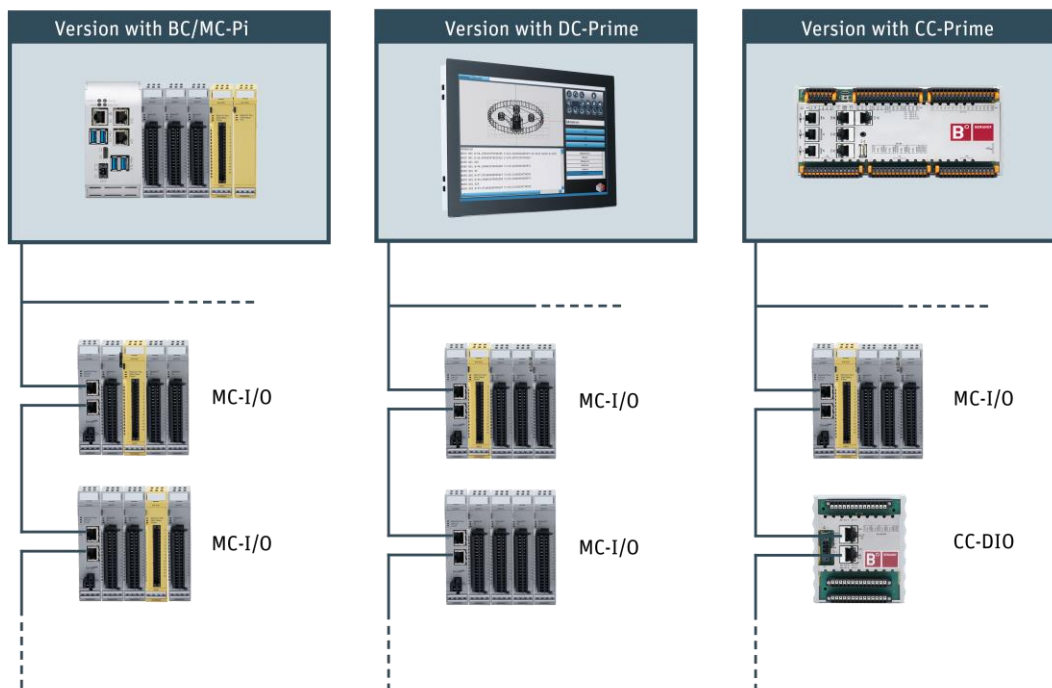

Figure 1: Overview of variants

2.4. Electromagnetic compatibility

2.4.1. Definition

Electromagnetic compatibility is the ability of a device to function satisfactorily in its electromagnetic environment without itself causing any electromagnetic interference that would be intolerable to other devices in this environment.

Of all known phenomena of electromagnetic noise, only a certain range occurs at the location of a given device. It is defined in the relevant product standards.

The design and immunity to interference of programmable logic controllers are internationally governed by Standard IEC 61131-2 which, in Europe, has been the basis for European Standard EN 61131-2.

i NOTE

Refer to IEC 61131-4, User's Guideline, for general installation instructions to be complied with to ensure that hardware interface factors and the ensuing noise voltages are limited to tolerable levels.

2.4.2. Interference emission

Interfering emission of electromagnetic fields, HF compliant to EN 55011, limiting value class A, Group 1

i NOTE

If the controller is designed for use in residential areas, high-frequency emissions must comply with limiting value class B as described in EN 55011. Fitting the controller into earthed metal cabinets and in-stalling filters in the supply lines may produce a shielding compliant to the above standard.

2.4.3. General notes on installation

As component parts of machines, facilities and systems, electronic control systems must comply with valid rules and regulations, depending on their field of application.

General requirements concerning the electrical equipment of machines and aiming at the safety of these machines are contained in Part 1 of European Standard EN 60204 (same as VDE 0113).

For safe installation of our control system please observe the information given below.

2.4.4. Electrical immission safeguard

Connect the control system to the protective earth conductor to eliminate electromagnetic interference. Practice best cable routing.

2.4.5. Cable routing and wiring

Keep power circuits separate from control circuits:

- DC voltages 60 V ... 400 V
- AC voltages 25 V ... 400 V

Joint laying of control circuits is allowed for:

- shielded data signals
- shielded analogue signals
- unshielded digital I/O lines
- unshielded DC voltages < 60 V
- unshielded AC voltages < 25 V

Wire connection specifications: Use AWG wire size 16-22 or equivalent.

2.4.6. Location of installation

Exclude any and all impediments due to temperature, dirt, impact, vibration or electromagnetic interference.

Temperature

Consider heat sources such as general heating of rooms, sunlight, heat accumulation in assembly rooms or control cabinets.

Contamination

Use suitable casings to avoid possible negative influences due to humidity, corrosive gas, liquid or conducting dust.

Impact and vibration

Consider possible influences caused by motors, compressors, transfer lines, presses, ramming machines and vehicles.

Electromagnetic interference

Consider electromagnetic interference from various local sources: motors, switching devices, switching thyristors, radio-controlled devices, welding equipment, arcing, switched-mode power supplies, converters / inverters.

2.4.7. Particular sources of interference

Inductive actuators

Switching off inductances (such as from relays, contactors, solenoids or switching magnets) produces surge voltages. It is necessary to reduce these extra voltages to a minimum. Reducing elements may be diodes, Z-diodes, varistors or RC elements. To find the best adapted elements, we recommend that you contact the manufacturer or supplier of the corresponding actuators for the relevant information.

3. System description EtherCAT I/O Modules

B-Nimis MC-I/O is a system of I/O modules for connecting the process signals to any EtherCAT network station.

B-Nimis MC-I/O consists of the B-Nimis MC-I/O bus coupler and a range of B-Nimis MC-I/O modules. The B-Nimis MC-I/O bus coupler converts the physical transfer technology (twisted pair) to LVDS (E-bus) and generates the system voltages required by the LVDS modules. The standard 100 Base Tx lines used for office network communications connect to the one side, the B-Nimis MC-I/O modules for the process signals connect to the other. This is how the Ethernet EtherCAT protocol is retained right through to the last I/O module. At the end of the modular device, the connection between the forward and return lines is automatically closed, the effect being that another 100 Base Tx line can be plugged in to connect the next EtherCAT unit to the second bus coupler port.

If the bus coupler is the last station of the EtherCAT network, i.e. if its RJ45 "Out" socket remains unplugged, the connection between the forward and return lines is automatically closed.

3.1. Mechanical design

The figure shows the basic layout of the B-Nimis MC-I/O modules.

The bus coupler and the I/O modules differ in their connectors and indicators, however.

Module structure

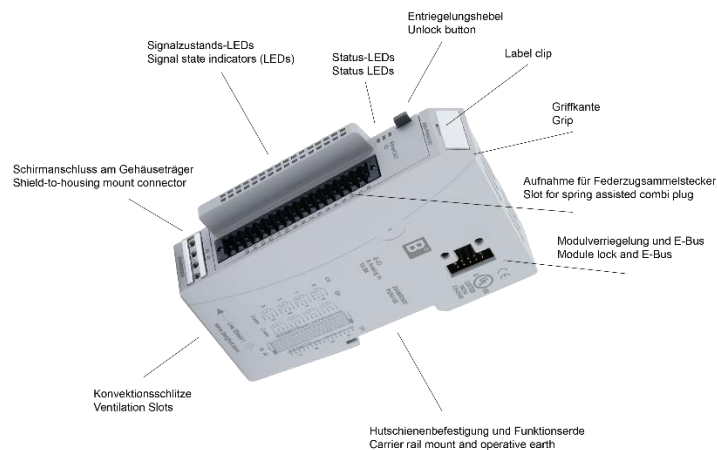

Figure 2: Mechanical design

The housing mount consists of an aluminium profile with an integral snap-on device used to snap the module to a 35mm DIN rail.

The housing trough including the optical fibres for the status indicators, the side face and the front is made of plastic and contains the module.

The optical fibres for the signal state indicators (LEDs) are located next to the spring-assisted combi plug. They slightly protrude from the housing and allow a clear diagnosis at a glance.

3.1.1. Earth

The B-Nimis MC-I/O modules shall be earthed. Thereto the metal housing shall be attached to operative earth.

Since the operative earth connectors dissipate HF currents, it is of utmost importance for the module's noise immunity.

HF interference is dissipated from the electronics board to the metal housing. The metal housing therefore needs to be suitably connected to an operative earth connector.

You will normally have to ensure that

- the connection between module housing and DIN rail conducts well,
- the connection between DIN rail and switching cabinet conducts well,
- the switching cabinet is safely connected to earth.

In special cases you may attach the earth wire straight to the module.

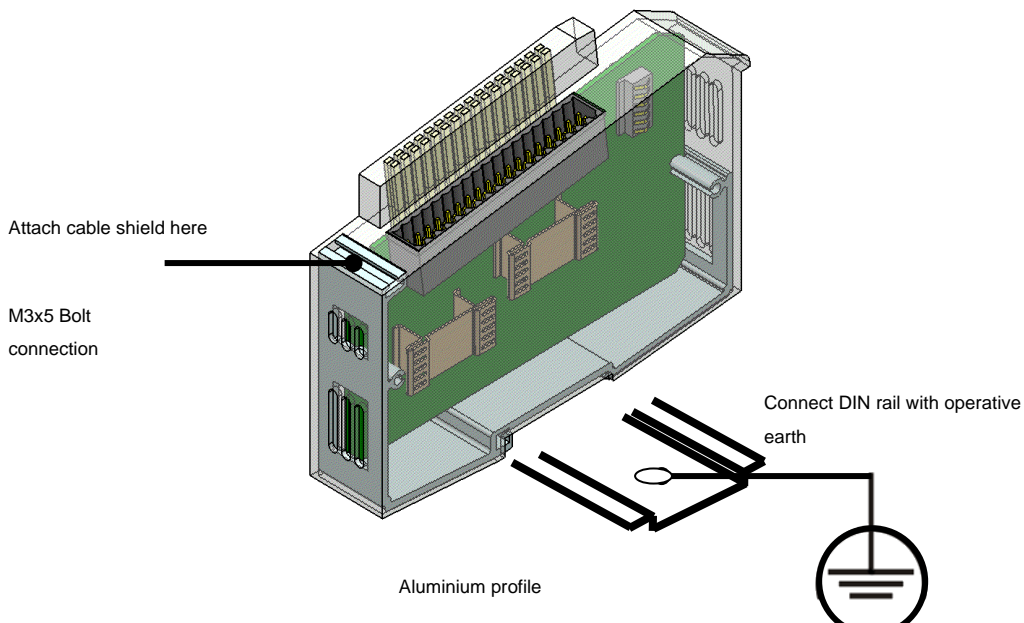

Figure 3: Earth

i NOTE

Earth wires should be short and have a large surface (copper mesh).

Further details has site [http://en.wikipedia.org/wiki/Ground_\(electricity\)](http://en.wikipedia.org/wiki/Ground_(electricity))

3.1.2. Installation

The B-Nimis MC-I/O modules are intended for mounting rail installation (DIN EN 50022, 35 x 7.5 mm).

The mounting rail is placed horizontally and the female connector strip of the modules face forward. For a sufficient ventilation of the convection slits the minimum distance must not fall below 20 mm upward and 35 mm to adjacent equipment and control cabinets. The lateral distance to external devices and cabinet controls must not fall below 20 mm.

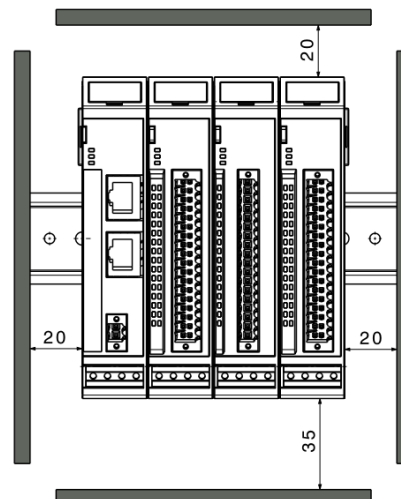

Figure 4: Installation position

Installation order within an MC-I/O system

i NOTE

To ensure smooth function of the entire MC-I/O system, the MC-I/O modules must be arranged based on their e-bus load. The modules with the biggest e-bus load are to be arranged directly next to the head modules (bus coupler or controller). Make sure that you note the maximum bus load of the head module.

- Push up the module against the mounting rail from below, allowing the metal spring to snap in between mounting rail and mounting area as illustrated.
- Push the module above against the mounting wall until it snaps in.

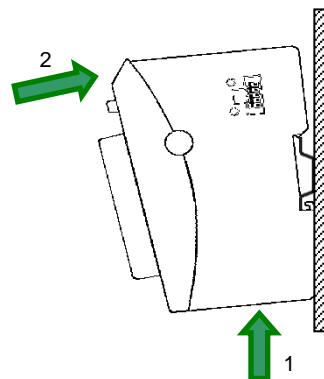

→ To snap on a single module

Figure 5: Rail mounting of module

To interconnect two modules

After snapping on the first module to the rail, snap on the second module about 1cm away towards the right of the first module. Push the second module along the rail towards the first module until you hear the locking device snap in.

To disconnect two modules

Push down the unlock button (see figure below) of the module that you wish to disconnect from the module to the left of it. Push both modules away from one another until they are about 1 cm apart.

- Push the module up and against the metal spring located on the underside of the rail guide.
- Tip the module away from the rail as shown in the illustration.
- Pull the module down and out of the mounting rail.

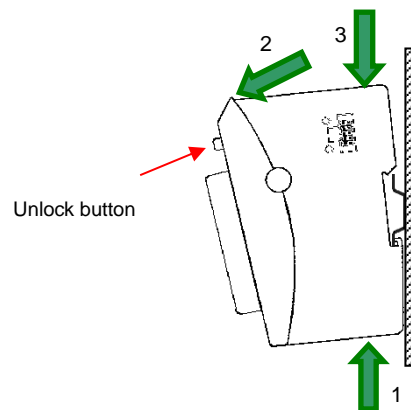

Figure 6: Uninstalling a module

3.2. System power supply

3.2.1. General

General Spring-assisted blocks of sockets allow fast and simple wiring. A multiple socket connector densely packs the wires on a small footprint. Use the unlock button to easily disconnect the wires where there is little space.

Tool: 0.4 x 2.5 blade screwdriver

Cores: 0.20 - 1.0 mm² (IEC) / 28 - 18 ENC (UL)

Rated current: 5 A (CSA) / 10 A (UL)

CAUTION

Do not connect the power supply lines through from one I/O power supply port to the next.

To ensure that there is as little interference as possible, install a central power supply point and establish a star topology of as short wires as possible between the central point and the I/O Modules.

3.2.2. Bus coupler

The system power supply connects to the bus coupler through a 2-pole plug-type terminal block. Since the bus coupler supplies power to both the E-bus and the logic circuits of the I/O modules, its power consumption depends on the number of I/O modules connected. Power to the I/O module outputs is supplied separately.



Spring-assisted connector and bus coupler unlock button
2VF100532DG00.cdr

3.2.3. I/O Modules

The I/O supply connects to the I/O module, normally together with the I/Os, using plug-type terminal blocks with different numbers of poles.

Power to the I/O module logic circuits is supplied by the bus coupler.



Spring-assisted connector with I/O module unlock button
2VF100533DG00.cdr

3.3. Status LEDs

3.3.1. “EtherCAT” LED

An LED labeled “EtherCAT” is located on both the bus coupler and the I/O Modules. It indicates the state of the EtherCAT ASIC.

EtherCAT		
State	LED flash code	Explanation
Init	Red, on	Initializing, no data exchange
Pre-Op	Red/green, 1:1	Pre-operational, no data exchange
Safe-Op	Red/green, 5:1	Safe operation, inputs readable
Op	Green, on	Operational, unrestricted data exchange

3.3.2. “In” LED, “Out” LED

The “In” and “Out” LEDs are located on the bus coupler. They indicate the respective physical state of the Ethernet.

Ethernet		
State	LED flash code	Explanation
Not connected	Off	No Ethernet connection
Connected	Green, on	Connected to Ethernet
Traffic	Green, flashing	Exchanging telegrams

3.3.3. “I/O” LED

Every I/O Module has an LED labeled "IO". It indicates the state of the Module's I/Os. Refer to the I/O Module sections in this manual to know which states of a module are monitored and indicated.

3.3.4. “Power” LED

An LED labeled “Power” is located on every I/O Module that has a power supply connector (e.g. for digital outputs). It indicates the state of the I/O module's I/O power supply.

I/O power supply		
State	LED flash code	Explanation
On	Green, on	24 V DC supply ok
Off	Off	24 V DC supply not ok

3.4. Technical data (overview)

System properties B-Nimis MC-I/O	
Fieldbus	EtherCAT 100Mbit/s
Dimensions	25 mm x 120 mm x 90 mm (W x H x D)
Housing mount	aluminium
Shield	connected straight to module housing
Installation	35 mm DIN rail (top-hat rail)
I/O connection	spring-assisted combi plug with mechanical ejector, 4 ... 36-pin
Signal indication	LED located next to the terminal
Diagnosis	LED: bus state, module state, broken wire/excessive current
Number of ports	up to 32 digital I/Os on every module, up to 8 analogue channels per module
Supply voltage	24 V DC -20% / +25%
Number of I/O modules	20 per bus coupler (total max. power consumption:3 A)
Electrical insulation	modules electrically insulated from one another and from the bus
Cable length analog signals	< 30 m
Storage temperature	-25 °C ... +70 °C
Operating temperature	0 °C ... +55 °C
Rel. humidity	5 % ... 95 %, non-condensing
Protection	IP20
Susceptibility to noise	zone B to EN 61131-2, installation on an earthed top hat rail in the earthed control

i NOTE

Exception

The dimensions of the Bus coupler DI16/DO16 amount to 42 mm x 120 mm x 90 mm (W x H x D).

3.5. MC-I/O Modules (overview)

MC-I/O Modules		
Label	Order number	Page
MC-I/O BUSKOPPLER 3A	S-01030203-0100	26
MC-I/O BK DI16/DO16 1MS/0,5A	S-01030203-0200	29
MC-I/O DI16/DO16 1MS/0,5A	S-01030201-0400	33
MC-I/O DI32 1MS	S-01030201-0200	36
MC-I/O DI16 1MS	S-01030201-0100	38
MC-I/O DO16 0,5A	S-01030201-0300	40
MC-I/O DO8 RELAIS NO 24V	S-01030205-0100	43
MC-I/O DO8 RELAIS NO 230VAC	S-01030205-0200	46
MC-I/O AI4-I 12BIT	204801100	49
MC-I/O AI8-I 12BIT	204802700	56
MC-I/O AI4-I 12BIT CoE	S-01030202-0100	64
MC-I/O AI8-I 12BIT CoE	S-01030202-0200	73
MC-I/O AI4/8-U 13BIT	204800200	82
MC-I/O AI4/8-U 13BIT CoE	S-01030202-0300	88
MC-I/O AI8/16-U 13BIT CoE	S-01030202-0400	97
MC-I/O AO4-U/I 12BIT	204801200	107
MC-I/O AO4-U/I 16BIT CoE	S-01030202-0500	115
MC-I/O AI4-PT/NI100 16BIT	204801300	122
MC-I/O AI4-PT/NI1000 16BIT	204802800	122
MC-I/O AI8-PT/NI100 16BIT	204800500	129
MC-I/O AI4-THERMO 16BIT	204801400	135
MC-I/O AI4-PT/NI/THERMO 16BIT CoE	S-01030204-0100	140
MC-I/O AI8-PT/NI/THERMO 16BIT CoE	S-01030204-0200	151
MC-I/O COUNTER/POSI2 5V	S-01030206-0100	165
MC-I/O CAN	S-01030203-0500	184
MC-I/O EXTENDER 2 PORT	S-01030203-0300	201
Supplement		
POTENTIALVERTEILER 2x16	204802300	204
SCHIRMANSCHLUSSKLEMME 2x8 mm	204802400	205

4. Bus coupler

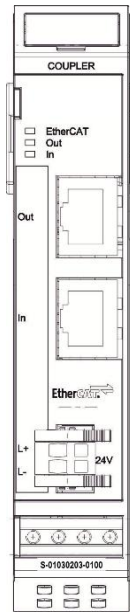

Figure 7: Bus coupler front view

4.1. Terminals

Module power supply

L+: 24 V DC

L-: 0 V

EtherCAT (RJ45 socket)

IN: input (from previous EtherCAT station)

OUT: output (to next EtherCAT station)

4.2. Status LEDs

“EtherCAT” LED

The LED labeled “EtherCAT” indicates the state of the EtherCAT ASIC.

EtherCAT		
State	LED flash code	Explanation
Init	Red, on	Initializing, no data exchange
Pre-Op	Red/green, 1:1	Pre-operational, no data exchange
Safe-Op	Red/green, 5:1	Safe operation, inputs readable
Op	Green, on	Operational, unrestricted data exchange

“In” LED, “Out” LED

The “In” and “Out” LEDs indicate the physical state of the Ethernet’s ports they are allocated to.

Ethernet		
State	LED flash code	Explanation
Not connected	Off	No Ethernet connection
Connected	Green, on	Connected to Ethernet
Traffic	Green, flashing	Exchanging telegrams

4.3. Function

The B-Nimis MC-I/O bus coupler converts the physical transfer technology (twisted pair) to LVDS (E-bus) and generates the system voltages required by the LVDS modules.

The standard 100 Base Tx lines used for office network communications connect to the one side, the B-Nimis MC-I/O Modules for the process signals connect to the other. This is how the Ethernet EtherCAT protocol is retained right through to the last I/O module.

At the end of the modular device, the connection between the forward and return lines is automatically closed, the effect being that another 100 Base Tx line can be plugged in to connect the next EtherCAT unit to the second bus coupler port.

Module state		
Variable	Data type	Explanation
Undervoltage	BOOL	Low voltage (supplied power < 19.2 V)

4.4. Technical data

Bus coupler	
Label	MC-I/O BUSKOPPLER 3A
Part no.	S-01030203-0100
Plug-in connector	2-pole S-02020201-1000 (part of the package)
Function	Connects a 100Base-TX EtherCAT with the B-Nimis MC-I/O Modules Generates the LVDS system voltages
Controller	ASIC ET1100
Baud rate	100Mbit/s
Cable	CAT5
Length of cable	max. 100 m between 2 bus couplers
Terminal EtherCAT	2 x RJ45
Power supply	24 V DC -20% +25%
Input current	50 mA & E-bus power supply
E-bus power supply	max. 3 A (ca. 20 modules)
E-bus load	195 mA
UL approval	 <p>UL LISTED 59DM E242595 IND.CONT.EQ.</p>

5. Digital modules with integrated bus coupler

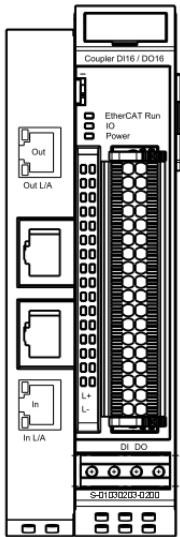

Figure 8: Front view of BK DI16/DO16 1MS/0.5A I/O module

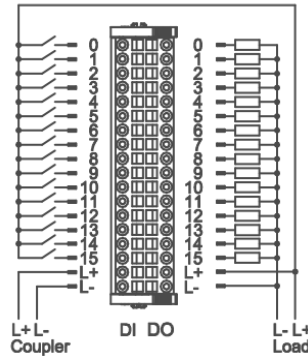

Figure 9: I/O connection

5.1. Terminals

Power supply to module I/Os

L+: 24 V DC

L-: 0 V

EtherCAT (RJ45 socket)

IN: input (from previous EtherCAT station)

OUT: output (to next EtherCAT station)

5.2. Status LEDs

“EtherCAT” LED

The LED labeled “EtherCAT” indicates the state of the EtherCAT ASIC.

EtherCAT		
State	LED flash code	Explanation
Init	Red, on	Initializing, no data exchange
Pre-Op	Red/green, 1:1	Pre-operational, no data exchange
Safe-Op	Red/green, 5:1	Safe operation, inputs readable
Op	Green, on	Operational, unrestricted data exchange

“I/O” LED

The LED labeled “IO” indicates the state of the module’s I/Os.

I/O		
State	LED	Explanation
Ok	Off	No error
SC	Red, flashing light	Short-circuited digital output

CAUTION

The output drivers have a thermal fuse to automatically turn off any short-circuited outputs.

In case the short circuit prevails, the outputs are allowed to cool down to be turned back on until the thermal fuse blows again.

“Power” LED

The LED labeled "Power" indicates the state of the I/O module's I/O power supply.

Power		
State	LED	Explanation
On	Green	24 V DC supply ok
Off	Off	24 V DC supply not ok

CAUTION

The module is monitored for low voltage states for logic and load!

“In”LED, “Out” LED

The “In” and “Out” LEDs indicate the physical state of the Ethernet’s ports they are allocated to.

Ethernet		
State	LED flash code	Explanation
Not connected	Off	No Ethernet connection
Connected	Green, on	Connected to Ethernet
Traffic	Green, flashing light	Exchanging telegrams

“Channel” LEDs

Channel		
State	LED	Explanation
On	Green, on	Input signal TRUE / output enabled
Off	Off	Input signal FALSE / output disabled

5.3. Function

The B-Nimis MC-I/O Bus coupler DI16/DO16 is an EtherCAT I/O module that combines the functionalities of the existing single modules B-Nimis MC-I/O Bus coupler and B-Nimis MC-I/O DI16/DO16 into one device. It is designed with a reduced E-bus supply of 2 A specifically for use in smaller module blocks.

In the bus coupler part the module converts the transmission physics from Twisted Pair to LVDS (E-Bus) and the generation of the voltage for the LVDS modules takes place. In addition, the module has 16 digital inputs and 16 digital outputs.

About the lateral E-bus connection, the Bus coupler DI16/DO16 can also be flexibly extended with EtherCAT I/O modules of the series B-Nimis MC-I/O.

Module state		
Variable	Data type	Explanation
U24_Load	BOOL	Undervoltage (supply < 19.2 V)
U24_Logic	BOOL	Undervoltage (supply < 19.2 V)
ShortcutOutput	BOOL	Short-circuited digital output

5.4. Technical data

BK DI16 / DO16	
Label	MC-I/O BK DI16/DO16 1MS/0.5A
Part no.	S-01030203-0200
Plug-in connector	36-pole S-02020201-0900 (not part of the package)
Function	Connects a 100Base-TX EtherCAT with the B-Nimis MC-I/O Modules Generates the LVDS system voltages
Digital inputs	16
Input delay	3 ms (typical)
Signal level	Off: -3 ... 5 V (EN 61131-3, Type1) On: 15 V ... 30 V
Digital outputs	16
Max. current	0.5 A per output
Total current	max. 8 A
Controller	ASIC ET1100
Baud rate	100 Mbit/s
Cable	CAT5
Cable length	max. 100 m between 2 bus couplers
EtherCAT connection	2 x RJ45
Power supply	24 V DC -20% +25%
Input current	40 mA & E-bus power supply
E-bus power supply	max. 2 A (ca. 11 modules)
E-bus connector	10-pin system plug in side wall
Term. module	not required
UL approval	 <p> UL LISTED <small>59DM</small> <small>E242595</small> <small>IND.CONT.EQ.</small> </p>

6. Digital modules

6.1. Digital in- and outputs DI16 / DO16

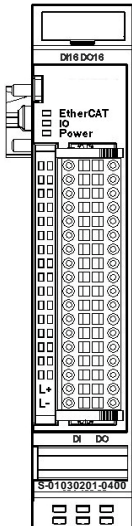

Figure 10: Front view of DI16/DO16 I/O module

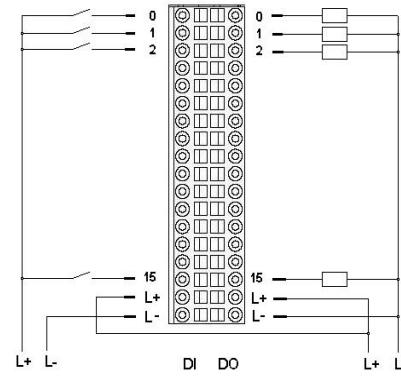

Figure 11: I/O connection

6.1.1. Terminals

Power supply to module I/Os

L+: 24 V DC

L-: 0 V

⚠ CAUTION

Connect L+ to both L+ terminals if the total current exceeds the 6A limit.

6.1.2. Status LEDs

“EtherCAT” LED

The LED labeled “EtherCAT” indicates the state of the EtherCAT ASIC.

EtherCAT		
State	LED flash code	Explanation
Init	Red, on	Initializing, no data exchange
Pre-Op	Red/green, 1:1	Pre-operational, no data exchange
Safe-Op	Red/green, 5:1	Safe operation, inputs readable
Op	Green, on	Operational, unrestricted data exchange

“I/O” LED

The LED labeled “IO” indicates the state of the module’s I/Os.

I/O		
State	LED flash code	Explanation
Ok	Off	No error
SC	Red, on	Short-circuited digital output

⚠ CAUTION

The output drivers have a thermal fuse to automatically turn off any short-circuited outputs.

In case the short circuit prevails, the outputs are allowed to cool down to be turned back on until the thermal fuse blows again.

“Power” LED

The LED labeled "Power" indicates the state of the I/O module's I/O power supply.

Power		
State	LED flash code	Explanation
On	Green, on	24 V DC supply ok
Off	Off	24 V DC supply not ok

⚠ CAUTION

The module is not monitored for low voltage states.

“Channel” LEDs

Channel		
State	LED	Explanation
On	Green, on	Input signal TRUE / output enabled
Off	Off	Input signal FALSE / output disabled

6.1.3. Function

The DI16/DO16 module features 16 digital inputs and 16 digital outputs.

Function		
Variable	Data type	Explanation
DigitalInputn	BOOL	Digital input (n=0...15)
DigitalOutputn	BOOL	Digital output (n=0...15)

6.1.4. Technical data

DI16 / DO16	
Label	MC-I/O DI16/DO16 1MS/0.5A
Part no.	S-01030201-0400
Plug-in connector	36-pole S-02020201-0900 (not part of the module)
Digital inputs	16
Input delay	1 ms / 5 ms (typically)
Signal level	Off: -3 ... 5 V (EN 61131-3, Type1) On: 15 V ... 30 V
Digital outputs	16
Max. current	0.5 A per output
Total current	max. 8 A
Controller	ASIC ET1200
Baud rate	100 Mbit/s
Connector	10-pin system plug in side wall
Term. module	not required
Power supply	24 V DC -20% +25%
E-bus load	135 mA
UL approval	 LISTED 59DM E242595 IND.CONT.EQ.

6.2. Digital inputs DI32

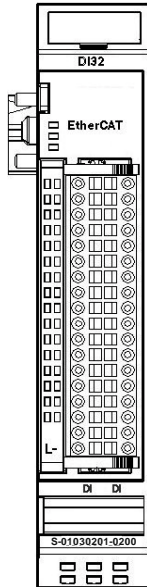

Figure 12: Front view of DI32 I/O module

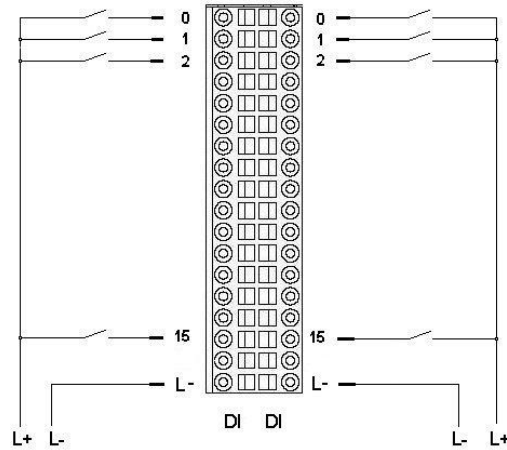

Figure 13: I/O connection

6.2.1. Terminals

Power supply to module I/Os

L-: 0 V

6.2.2. Status LEDs

“EtherCAT” LED

The LED labeled “EtherCAT” indicates the state of the EtherCAT ASIC.

EtherCAT		
State	LED flash code	Explanation
Init	Red, on	Initializing, no data exchange
Pre-Op	Red/green, 1:1	Pre-operational, no data exchange
Safe-Op	Red/green, 5:1	Safe operation, inputs readable
Op	Green, on	Operational, unrestricted data exchange

“I/O” LED

There is no LED labeled “I/O”.

“Power” LED

There is no LED labeled “Power” because a separate power feed is not required.

“Channel” LEDs

Channel		
State	LED	Explanation
On	Green, on	Input signal TRUE
Off	Off	Input signal FALSE

6.2.3. Function

The DI32 module has 32 digital inputs.

Function		
Variable	Data type	Explanation
DigitalInputn	BOOL	Digital input (n=0...31)

6.2.4. Technical data

DI32	
Label	MC-I/O DI32 1MS
Part no.	S-01030201-0200
Plug-in connector	36-pole S-02020201-0900 (not part of the module)
Digital inputs	32
Input delay	1 ms / 5 ms (typically)
Signal level	Off: -3 ... 5 V (EN 61131-3, Type1) On: 15 V ... 30 V
Controller	ASIC ET1100
Baud rate	100 Mbit/s
Connector	10-pin system plug in side wall
Term. module	not required
Power supply	24 V DC -20 % +25 %
E-bus load	85 mA
UL approval	 LISTED 59DM E242595 IND.CONT.EQ.

6.3. Digital inputs DI16

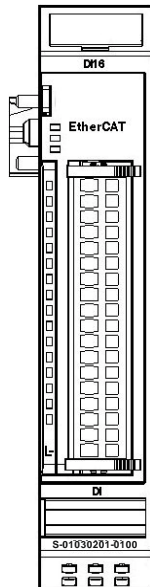

Figure 14: Front view of DI16 I/O module

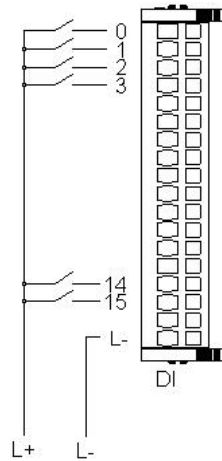

Figure 15: I/O connection

6.3.1. Terminals

Power supply to module I/Os

L-: 0 V

6.3.2. Status LEDs

“EtherCAT” LED

The LED labeled “EtherCAT” indicates the state of the EtherCAT ASIC.

EtherCAT		
State	LED flash code	Explanation
Init	Red, on	Initializing, no data exchange
Pre-Op	Red/green, 1:1	Pre-operational, no data exchange
Safe-Op	Red/green, 5:1	Safe operation, inputs readable
Op	Green, on	Operational, unrestricted data exchange

“I/O” LED

There is no LED labeled “I/O”.

“Power” LED

There is no LED labeled “Power” because a separate power feed is not required.

“Channel” LEDs

Channel		
State	LED	Explanation
On	Green, on	Input signal TRUE
Off	Off	Input signal FALSE

6.3.3. Function

The DI16 module has 16 digital inputs.

Function		
Variable	Data type	Explanation
DigitalInputn	BOOL	Digital input (n=0...15)

6.3.4. Technical data

DI16	
Label	MC-I/O DI16 1MS
Part no.	S-01030201-0100
Plug-in connector	18-pole S-02020201-0800 (not part of the module)
Digital inputs	16
Input delay	1 ms / 5 ms (typically)
Signal level	Off: -3 ... 5 V (EN 61131-3, Type1) On: 15 V ... 30 V
Controller	ASIC ET1200
Baud rate	100 Mbit/s
Connector	10-pin system plug in side wall
Term. module	not required
Power supply	24 V DC -20% +25%
E-bus load	100 mA
UL approval	 <p>UL LISTED 59DM E242595 IND.CONT.EQ.</p>

6.4. Digital outputs DO16

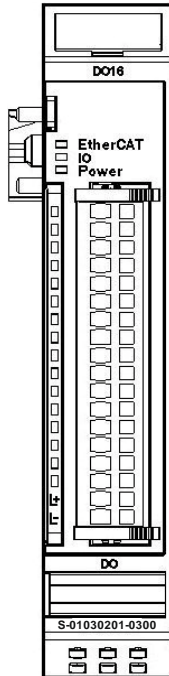

Figure 16: Front view of DO16 I/O module

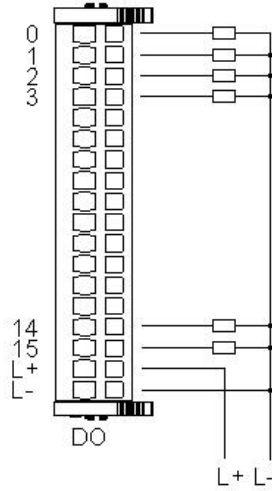

Figure 17: I/O connection

6.4.1. Terminals

Power supply to module I/Os

L+: 24 V DC

L-: 0 V

6.4.2. Status LEDs

“EtherCAT” LED

The LED labeled “EtherCAT” indicates the state of the EtherCAT ASIC.

EtherCAT		
State	LED flash code	Explanation
Init	Red, on	Initializing, no data exchange
Pre-Op	Red/green, 1:1	Pre-operational, no data exchange
Safe-Op	Red/green, 5:1	Safe operation, inputs readable
Op	Green, on	Operational, unrestricted data exchange

“I/O” LED

The LED labeled “I/O” indicates the state of the module’s I/Os.

I/O		
State	LED flash code	Explanation
Ok	Off	No error
SC	Red, on	Short-circuited digital output

CAUTION

The output drivers have a thermal fuse to automatically turn off any short-circuited outputs.

In case the short circuit prevails, the outputs are allowed to cool down to be turned back on until the thermal fuse blows again.

“Power” LED

The LED labeled "Power" indicates the state of the I/O module's I/O power supply.

Power		
State	LED flash code	Explanation
On	Green, on	24 V DC supply ok
Off	Off	24 V DC supply not ok

CAUTION

The module is not monitored for low voltage states.

“Channel” LEDs

Channel		
State	LED	Explanation
On	Green, on	Output enabled
Off	Off	Output disabled

6.4.3. Function

The DO16 module has 16 digital outputs.

Function		
Variable	Data type	Explanation
DigitalOutputn	BOOL	Digital output (n=0...15)

6.4.4. Technical data

DO16	
Label	MC-I/O DO16 0,5A
Part no.	S-01030201-0300
Plug-in connector	18-pole S-02020201-0800 (not part of the module)
Digital outputs	16
Max. current	0,5 A per output
Total current	max. 8 A
Controller	ASIC ET1200
Baud rate	100 Mbit/s
Connector	10-pin system plug in side wall
Term. module	not required
Power supply	24 V DC -20% +25%
E-bus load	130 mA
UL approval	

6.5. Digital outputs DO8 RELAIS NO 24V

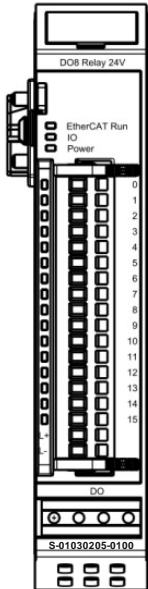

Figure 18: Front view of DO8 RELAIS NO 24V I/O module

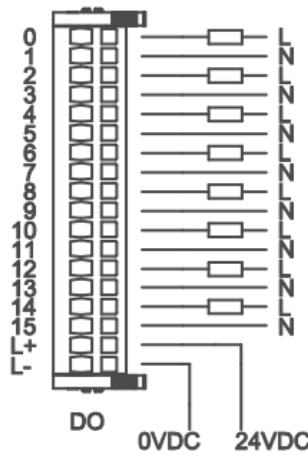

Figure 19: I/O connection

OUT	Pin
0-a	0
0-b	1
1-a	2
1-b	3
2-a	4
2-b	5
3-a	6
3-b	7
4-a	8
4-b	9
5-a	10
5-b	11
6-a	12
6-b	13
7-a	14
7-b	15
24 V	16
0 V	17

6.5.1. Terminals

Power supply to module I/Os

L+: 24 V DC

L-: 0 V

6.5.2. Status LEDs

“EtherCAT” LED

The LED labeled “EtherCAT” indicates the state of the EtherCAT ASIC.

EtherCAT		
State	LED flash code	Explanation
Init	Red, on	Initializing, no data exchange
Pre-Op	Red/green, 1:1	Pre-operational, no data exchange
Safe-Op	Red/green, 5:1	Safe operation, inputs readable
Op	Green, on	Operational, unrestricted data exchange

“I/O” LED

There is no LED labeled “I/O”.

“Power” LED

The LED labeled "Power" indicates the state of the I/O module's I/O power supply.

Power		
State	LED	Explanation
On	Green	24 V DC supply ok
Off	Off	24 V DC supply not ok

“Channel” LEDs

Channel		
State	LED	Explanation
On	Green, on	Output enabled
Off	Off	Output disabled

6.5.3. Function

The DO8 RELAIS NO 24V module has 8 relay outputs.

Function		
Variable	Data type	Explanation
DigitalOutputn	BOOL	Digital output (n=0...7)
Reserved	BOOL	Unused output addresses

6.5.4. Technical data

DO8 RELAIS NO 24V	
Label	MC-I/O DO8 RELAIS NO 24V
Part no.	S-01030205-0100
Plug-in connector	18-pole S-02020201-0800 (not part of the module)
Digital outputs	8 closing relays
Max. switching current (ohmic)	5.0 A per output
Max. switching current (inductive)	2.0 A per output
Min. permitted load	10 mA @ 5 VDC
Operating cycles mech. (min.)	2×10^7
Operating cycles electr. (min.)	3×10^5 (2 A / 30 VDC)
Switching voltage	max. 24 VDC / VAC
Controller	ASIC ET1200
Baud rate	100 Mbit/s
E-bus connector	10-pin system plug in side wall
Term. module	not required
Power supply	24 V DC -20% +25%
E-bus load	130 mA

i NOTE

The UL approval for this module is in process of planning.

6.6. Digital outputs DO8 RELAIS NO 230VAC

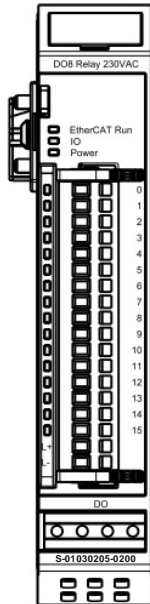

Figure 20: Front view of DO8 RELAIS NO 230VAC I/O module

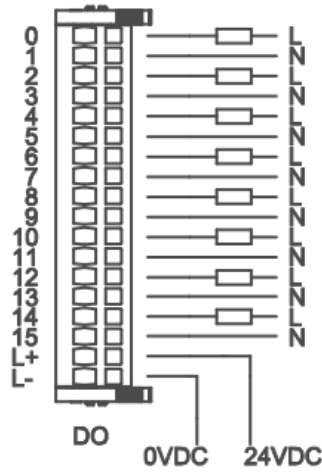

Figure 21: I/O connection

OUT	Pin
0-a	0
0-b	1
1-a	2
1-b	3
2-a	4
2-b	5
3-a	6
3-b	7
4-a	8
4-b	9
5-a	10
5-b	11
6-a	12
6-b	13
7-a	14
7-b	15
24 V	16
0 V	17

6.6.1. Terminals

Power supply to module I/Os

L+: 24 V DC

L-: 0 V

6.6.2. Status LEDs

“EtherCAT” LED

The LED labeled “EtherCAT” indicates the state of the EtherCAT ASIC.

EtherCAT		
State	LED flash code	Explanation
Init	Red, on	Initializing, no data exchange
Pre-Op	Red/green, 1:1	Pre-operational, no data exchange
Safe-Op	Red/green, 5:1	Safe operation, inputs readable
Op	Green, on	Operational, unrestricted data exchange

“I/O” LED

There is no LED labeled “I/O”.

“Power” LED

The LED labeled "Power" indicates the state of the I/O module's I/O power supply.

Power		
State	LED	Explanation
On	Green	24 V DC supply ok
Off	Off	24 V DC supply not ok

“Channel” LEDs

Channel		
State	LED	Explanation
On	Green, on	Output enabled
Off	Off	Output disabled

6.6.3. Function

The DO8 RELAIS NO 230VAC module has 8 relay outputs.

Function		
Variable	Data type	Explanation
DigitalOutputn	BOOL	Digital output (n=0...7)
Reserved	BOOL	Unused output addresses

6.6.4. Technical data

DO8 RELAIS NO 230VAC	
Label	MC-I/O DO8 RELAIS NO 230VAC
Part no.	S-01030205-0200
Plug-in connector	18-pole S-02020201-0800 (not part of the module)
Digital outputs	8 closing relays
Max. switching current (ohmic)	5.0 A je Ausgang
Max. switching current (inductive)	2.0 A je Ausgang
Min. permitted load	10 mA @ 5 VDC
Operating cycles mech. (min.)	2×10^7
Operating cycles electr. (min.)	3×10^5 (2 A / 30 VDC)
Switching voltage	max. 24 VDC / 230 VAC
Controller	ASIC ET1200
Baud rate	100 Mbit/s
E-bus connector	10-pin system plug in side wall
Term. module	not required
Power supply	24 V DC -20% +25%
E-bus load	130 mA

i NOTE

The UL approval for this module is in process of planning.

7. Analogue modules

7.1. Analogue inputs for current measurement AI4-I

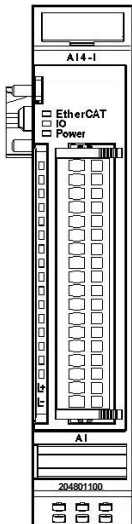

Figure 22: Front view of AI4-I I/O module

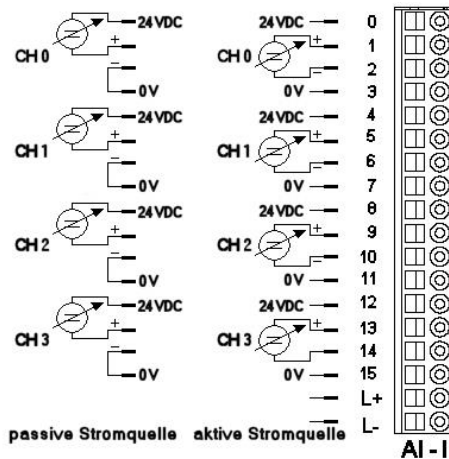

Figure 23: I/O connection passive/active power source

i NOTE

The AI4-I module is no longer recommended for new projects. Please use the successive AI4-I 12BIT CoE module.

7.1.1. Terminals

Module supply

L+: 24 V DC

L-: 0 V

Operative earth / shielding of analog wires → section 3.1.1 Earth

7.1.2. Status LEDs

“EtherCAT” LED

The LED labeled “EtherCAT” indicates the state of the EtherCAT ASIC.

EtherCAT		
State	LED flash code	Explanation
Init	Red, on	Initializing, no data exchange
Pre-Op	Red/green, 1:1	Pre-operational, no data exchange
Safe-Op	Red/green, 5:1	Safe operation, inputs readable
Op	Green, on	Operational, unrestricted data exchange

“I/O” LED

The LED labeled “I/O” indicates the state of the module's I/Os.

I/O		
State	LED flash code	Explanation
Ok	Green, on	No error
Error	Off	Malfunction of module if E-bus LED = On
		Inoperative if E-bus LED = Off
	Red, 2x	Undervoltage (not implemented)
	Red, 3x	Watchdog
	Red, 4x	EtherCAT watchdog control
	Red, 6x	Module-specific fault
	Red, 7x	Configuration error (E-bus pre-operational), no. of process data differs from that in the module
Defective	Red, on	Module defective

“Power” LED

The LED labeled "Power" indicates the state of the I/O module's I/O power supply.

Power		
State	LED flash code	Explanation
On	Green, on	24 V DC supply ok
Off	Off	24 V DC supply not ok

“Channel” LEDs

Channel		
State	LED flash code	Explanation
On	Green, on	Channel enabled
Off	Off	Channel disabled
Error	Red	Open, overcurrent

7.1.3. Function

The AI4-I module has 4 analogue current signal inputs. Their measuring range can be set separately for every channel, i.e. either to 0..20 mA or to 4..20 mA.

Analogue inputs

Check the following variable for the digitized input values:

Inputs		
Variable	Data type	Explanation
Channel_n	INT	Value measured on channel n (n= 0...3)

Measured value

The maximal measuring value (0xFFF0) of the current input module is $0.5 \text{ V} / 23.4 \Omega = 21.3675 \text{ mA}$.
The status is shown by the channel LED.

Measuring values, variable values and status

Measuring range *



* The measurement range is provided by the module, i.e the maximal output value is HEX FB80.

Mode 0 .. 20 mA



Mode 4 .. 20 mA



Conversion Output value -> Current [mA]:

$$\text{Current [mA]} = \text{Output value} / 3066,336$$

Conversion Current [mA] -> Output value:

$$\text{Output value} = \text{Roundoff} (\text{Current [mA]} * 191,646) * 16$$

Analogue values current

Measuring	Variable value			
	mA	decimal	CODESYS (INT)	hexadecimal
0	0	0	0	0
1	3056	3056	3056	16#0BF0
2	6128	6128	6128	16#17F0
3	9184	9184	9184	16#23E0
4	12256	12256	12256	16#2FE0
5	15328	15328	15328	16#3BE0
6	18384	18384	18384	16#47D0
7	21456	21456	21456	16#53D0
8	24528	24528	24528	16#5FD0
9	27584	27584	27584	16#6BC0
10	30656	30656	30656	16#77C0
11	33728	-31808	-31808	16#83C0
12	36784	-28752	-28752	16#8FB0
13	39856	-25680	-25680	16#9BB0
14	42928	-22608	-22608	16#A7B0
15	45984	-19552	-19552	16#B3A0
16	49056	-16480	-16480	16#BFA0
17	52112	-13424	-13424	16#CB90
18	55184	-10352	-10352	16#D790
19	58256	-7280	-7280	16#E390
20	61312	-4224	-4224	16#EF80
20.5	62848	-2688	-2688	16#F580
...				
≥ 21.37	65520	-16	-16	16#FFF0

Module control

The module provides you with various operational options.

To set up the module choose the options as appropriate and accept by setting control bit "SetOptions" to a rising edge. The module will confirm by returning "OptionsSet".

There are various "module error" bits that the module uses to indicate errors. The states of the error bits are retained and also used for error indication by the "I/O" LED. To reset the error bits set control bit "ResetError" to a rising edge.

Error bits		
Variable	Data type	Explanation
SetOptions	BOOL	Rising edge <input type="checkbox"/> accepts module options
ResetError	BOOL	Rising edge <input type="checkbox"/> acknowledges error

Module options

The following options are available for module AI4-I:

Module options			
Variable	Data type		Explanation
Channel_n_0_20mA	BOOL	TRUE	Channel n to 0...20 mA
		FALSE	Channel n to 4...20 mA
Channel_n_On	BOOL		Enables channel n
Channel_n_Filter	USINT	0..255	Filter on channel n New values avail. in k/3 ms (k=0..255)
n		0 ... 3	Channel number

To set and accept options, see Module control

Module state

The following states are indicated:

Module state		
Variable	Data type	Explanation
Shortcut	BOOL	Short circuit
Undervoltage	BOOL	Low voltage (supplied power < 19.2 V)
Watchdog	BOOL	Internal watchdog of module
EtherCAT_Error	BOOL	Configuration error or watchdog control
Specific_Error	BOOL	Module-specific fault
OptionsSet	BOOL	Sent by module to acknowledge SetOptions

To reset the messages, see Module control

Module-specific messages

Apart from the module error messages, there is a set of messages containing details about the current state of the module:

Messages		
Variable	Data type	Explanation
Channel_n_Open	BOOL	4..20 mA mode: input current < 3.5 mA → Specific_Error = TRUE
Channel_n_Overcurrent	BOOL	Input current > 20.5 mA → Specific_Error = TRUE

These messages are automatically reset when the state concerned has returned to normal.

Conversion time

The analogue signals are converted one by one down every channel. Disabling one or several channels will shorten the entire A/D conversion cycle.

“Filter” in this case means to compute an average when the set filter time is over.

Analogue value conversion runs cyclically and is not synchronized with the receipt of EtherCAT telegrams.

The cycle consists of the analogue value conversion plus transmitting the values into the EtherCAT data area.

Channel	
Number of channels	Cycle time in ms (all filters=0)
1	0.27
2	0.41
3	0.55
4	0.69

i NOTE

If you are aiming for a high sampling frequency, the EtherCAT master should do the filtering (averaging) because it will normally have much more processing power.

i NOTE

Take the EtherCAT cycle into account to assess how much the values stored by the EtherCAT master are up-to-date. The module described in this section will accept the above times as the ideal EtherCAT cycle setup.

Quality of analogue values

The inputs connect to both active or passive current sensors.

The module provides terminals for the 24 V DC- supply to the transmitter of every channel.

Passive current sensors:

Interconnect the “-” and “0 V” terminals.

Active current sensors:

Use the power supplied by the module if at all possible.

If power to the current sensors is supplied by an external source, connect the 0 V terminal of that power source to the 0 V terminal of the module.

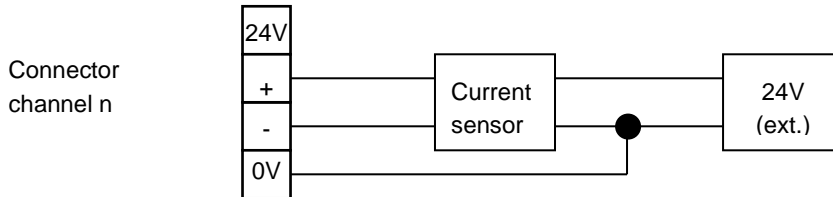

i NOTE

Best results are obtained by connected the shield of the signal cables to operative earth.

7.1.4. Technical data

AI4-I	
Label	MC-I/O AI4-I 12BIT
Part no.	204801100
Plug-in connector	18-pole S-02020201-0800 (not part of the module)
Analogue inputs	4 single ended
Resolution	12 Bit (5.2 µA)
Measuring range	0 ... 20 mA, 4..20 mA (limit 21.3675 mA)
Temperature drift	< ± 25 ppm/°C regarding range limit
Critical frequency	typical 12.5 kHz
Burden	< 75 Ω
Sampling frequency	1.45 kHz (if all channels are enabled)
Controller	ASIC ET1200
Baud rate	100 Mbit/s
E-bus port	10-pin system plug in side wall
Term. module	not required
Power supply	from coupler through E-bus connector
E-bus load	140 mA
UL approval	

7.2. Analogue inputs for current measurement AI8-I

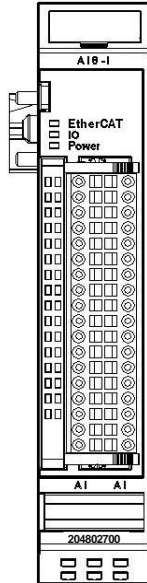

Figure 24: Front view of AI8-I I/O module

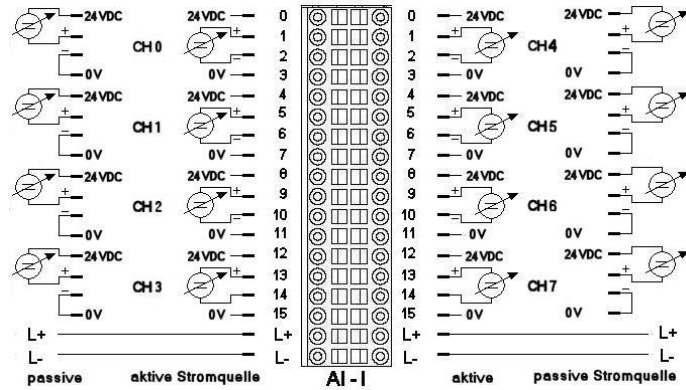

Figure 25: I/O connection passive/active power source

NOTE

The AI8-I module is no longer recommended for new projects. Please use the successive AI8-I 12BIT CoE module.

7.2.1. Terminals

Module supply

L+: 24 V DC

L-: 0 V

Operative earth / shielding of analog wires □ section 3.1.1 Earth

7.2.2. Status LEDs

“EtherCAT” LED

The LED labeled “EtherCAT” indicates the state of the EtherCAT ASIC.

EtherCAT		
State	LED flash code	Explanation
Init	Red, on	Initializing, no data exchange
Pre-Op	Red/green, 1:1	Pre-operational, no data exchange
Safe-Op	Red/green, 5:1	Safe operation, inputs readable
Op	Green, on	Operational, unrestricted data exchange

“I/O” LED

The LED labeled “I/O” indicates the state of the module's I/Os.

I/O		
State	LED flash code	Explanation
Ok	Green, on	No error
Error	Off	Malfunction of module if E-bus LED = On
		Inoperative if E-bus LED = Off
	Red, 2x	Undervoltage (not implemented)
	Red, 3x	Watchdog
	Red, 4x	EtherCAT watchdog control
	Red, 6x	Module-specific fault
	Red, 7x	Configuration error (E-bus pre-operational), no. of process data differs from that in the module
Defective	Red, on	Module defective

“Power” LED

The LED labeled "Power" indicates the state of the I/O module's I/O power supply.

Power		
State	LED flash code	Explanation
On	Green, on	24 V DC supply ok
Off	Off	24 V DC supply not ok

“Channel” LEDs

Channel		
State	LED flash code	Explanation
On	Green, on	Channel enabled
Off	Off	Channel disabled
Error	Red	Open, overcurrent

7.2.3. Function

The AI8-I module has 8 analogue current signal inputs. Their measuring range can be set separately for every channel, i.e. either to 0..20 mA or to 4..20 mA.

Analogue inputs

Check the following variable for the digitized input values:

Inputs		
Variable	Data type	Explanation
Channel_n	INT	Value measured on channel n (n= 0...7)

Measured value

The maximal measuring value (0xFFFF) of the current input module is $0.5 \text{ V} / 23.4 \Omega = 21.3675 \text{ mA}$.

The status is shown by the channel LED.

Measuring values, variable values and status

Measuring range *



* The measurement range is provided by the module, i.e the maximal output value is HEX FB80.

Mode 0 .. 20 mA



Mode 4 .. 20 mA



Conversion Output value -> Current [mA]:

$$\text{Current [mA]} = \text{Output value} / 3066,336$$

Conversion Current [mA]-> Output value:

$$\text{Output value} = \text{Roundoff} (\text{Current [mA]} * 191,646) * 16$$

Figure 26: Measuring values

Analogue values current

Measuring	Variable value		
	decimal	CODESYS (INT)	hexadecimal
0	0	0	0
1	3056	3056	16#0BF0
2	6128	6128	16#17F0
3	9184	9184	16#23E0
4	12256	12256	16#2FE0
5	15328	15328	16#3BE0
6	18384	18384	16#47D0
7	21456	21456	16#53D0
8	24528	24528	16#5FD0
9	27584	27584	16#6BC0
10	30656	30656	16#77C0
11	33728	-31808	16#83C0
12	36784	-28752	16#8FB0
13	39856	-25680	16#9BB0
14	42928	-22608	16#A7B0
15	45984	-19552	16#B3A0
16	49056	-16480	16#BFA0
17	52112	-13424	16#CB90
18	55184	-10352	16#D790
19	58256	-7280	16#E390
20	61312	-4224	16#EF80
20.5	62848	-2688	16#F580
...			
≥ 21.37	65520	-16	16#FFF0

Module control

The module provides you with various operational options.

To set up the module choose the options as appropriate and accept by setting control bit "SetOptions" to a rising edge. The module will confirm by returning "OptionsSet".

There are various "module error" bits that the module uses to indicate errors. The states of the error bits are retained and also used for error indication by the "I/O" LED. To reset the error bits set control bit "ResetError" to a rising edge.

Error bits		
Variable	Data type	Explanation
SetOptions	BOOL	Rising edge <input type="checkbox"/> accepts module options
ResetError	BOOL	Rising edge <input type="checkbox"/> acknowledges error

Module options

The following options are available for module AI8-I:

Module options			
Variable	Data type		Explanation
Channel_n_0_20mA	BOOL	TRUE	Channel n to 0...20 mA
		FALSE	Channel n to 4...20 mA
Channel_n_On	BOOL		Enables channel n
Channel_n_Filter	USINT	0..255	Filter on channel n New values avail. in k/3 ms (k=0..255)
n		0 ... 7	Channel number

To set and accept options, see Module control

Module state

The following states are indicated:

Module state		
Variable	Data type	Explanation
Shortcut	BOOL	Short circuit
Undervoltage	BOOL	Low voltage (supplied power < 19.2 V)
Watchdog	BOOL	Internal watchdog of module
EtherCAT_Error	BOOL	Configuration error or watchdog control
Specific_Error	BOOL	Module-specific fault
OptionsSet	BOOL	Sent by module to acknowledge SetOptions

To reset the messages, see Module control

Module-specific messages

Apart from the module error messages, there is a set of messages containing details about the current state of the module:

Messages		
Variable	Data type	Explanation
Channel_n_Open	BOOL	4..20 mA mode: input current < 3.5 mA → Specific_Error = TRUE
Channel_n_Overcurrent	BOOL	Input current > 20.5 mA → Specific_Error = TRUE

These messages are automatically reset when the state concerned has returned to normal.

Conversion time

The analogue signals are converted one by one down every channel. Disabling one or several channels will shorten the entire A/D conversion cycle.

“Filter” in this case means to compute an average when the set filter time is over.

Analogue value conversion runs cyclically and is not synchronized with the receipt of EtherCAT telegrams.

The cycle consists of the analogue value conversion plus transmitting the values into the EtherCAT data area.

Conversion time			
Number of channels	Cycle time in ms	Number of channels	Cycle time in ms
1	0.40	5	0.92
2	0.53	6	1.06
3	0.66	7	1.19
4	0.79	8	1.32

i NOTE

If you are aiming for a high sampling frequency, the EtherCAT master should do the filtering (averaging) because it will normally have much more processing power.

i NOTE

Take the EtherCAT cycle into account to assess how much the values stored by the EtherCAT master are up-to-date. The module described in this section will accept the above times as the ideal EtherCAT cycle setup.

Quality of analogue values

The inputs connect to both active or passive current sensors.

The module provides terminals for the 24 V DC- supply to the transmitter of every channel.

Passive current sensors:

Interconnect the “-” and “0 V” terminals.

Active current sensors:

Use the power supplied by the module if at all possible.

If power to the current sensors is supplied by an external source, connect the 0 V terminal of that power source to the 0 V terminal of the module.

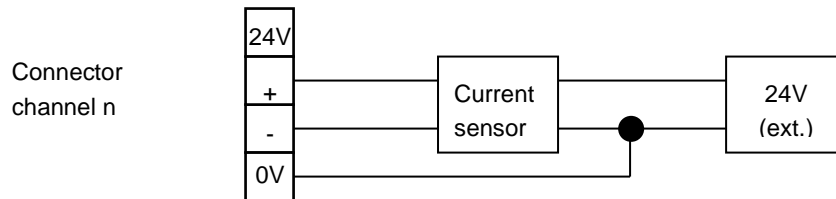

i NOTE

Best results are obtained by connected the shield of the signal cables to operative earth.

7.2.4. Technical data

AI8-I	
Label	MC-I/O AI8-I 12BIT
Part no.	204802700
Plug-in connector	36-pole S-02020201-0900 (not part of the module)
Analogue inputs	8 single ended
Resolution	12 Bit (5.2 μ A)
Measuring range	0 ... 20 mA, 4..20 mA (limit 21.3675 mA)
Temperature drift	< \pm 25 ppm/ $^{\circ}$ C regarding range limit
Critical frequency	typical 12.5 kHz
Burden	< 75 Ω
Sampling frequency	0.76 kHz (if all channels are enabled)
Controller	ASIC ET1200
Baud rate	100 Mbit/s
E-bus port	10-pin system plug in side wall
Term. module	not required
Power supply	from coupler through E-bus connector
E-bus load	160 mA
UL approval	 <p> UL LISTED <small>59DM</small> <small>E242595</small> <small>IND.CONTEQ.</small> </p>

7.3. Analogue inputs for current measurement AI4-I 12BIT CoE

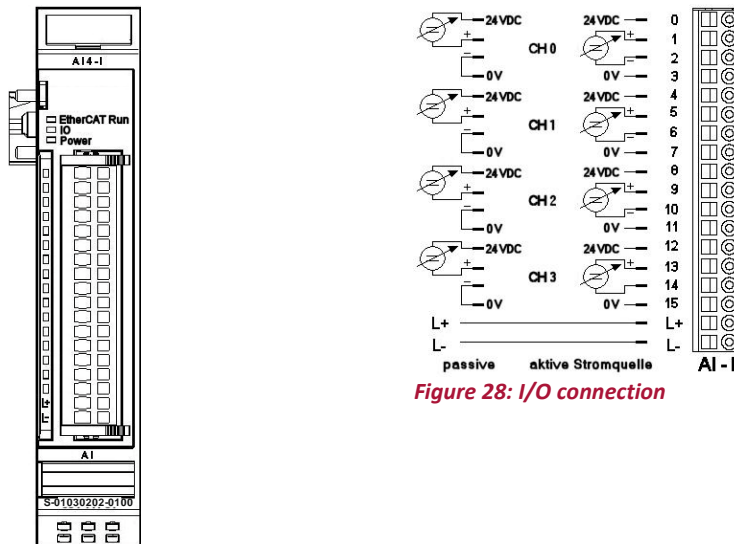

Figure 27: Front view of AI4-I 12BIT CoE I/O module

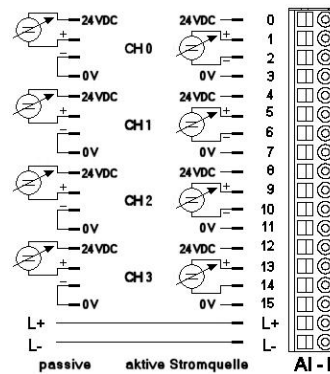

Figure 28: I/O connection

i NOTE

The AI4-I 12BIT CoE module is the successor module NOT compatible with the AI4-I module.

Before replacing an AI4-I module with an AI4-I 12BIT CoE module, you must modify the EtherCAT master's control program.

7.3.1. Terminals

The 24 V connector supplies power to the sensors. Power is supplied to the module through the E-bus connector.

Operative earth / shielding of analogue wires □ section 3.1.1 Earth

7.3.2. Status LEDs

“EtherCAT” LED

The LED labeled “EtherCAT” indicates the state of the EtherCAT ASIC.

EtherCAT		
State	LED flash code	Explanation
Init	Red, on	Initializing, no data exchange
Pre-Op	Red/green, 1:1	Pre-operational, no data exchange
Safe-Op	Red/green, 5:1	Safe operation, inputs readable
Op	Green, on	Operational, unrestricted data exchange

“I/O” LED

The LED labeled “I/O” indicates the state of the module's I/Os.

I/O		
State	LED flash code	Explanation
Ok	Green, on	No error
Error	Off	Malfunction of module if E-bus LED = On
		Inoperative if E-bus LED = Off
	Red, 4x	EtherCAT watchdog control
	Red, 7x	Configuration error (E-bus pre-operational), no. of process data differs from that in the module
Defective	Red, on	Module defective

“Power” LED

The LED labeled "Power" indicates the state of the power supplied to the I/O module's I/O sensors.

Power		
State	LED flash code	Explanation
On	Green, on	24 V DC supply ok
Off	Off	24 V DC supply not ok

“Channel” LEDs

The "Channel" LEDs indicate the state of every channel.

Channel		
State	LED flash code	Explanation
On	Green, on	Channel enabled
Off	Off	Channel disabled
Error	Red, 1x	Current > 20.5 mA
	Red, 2x	Current < 3.5 mA (4...20 mA mode)

7.3.3. Function

The AI4-I 12BIT CoE module has 4 analogue current signal inputs. Their measuring range can be set separately for every channel, i.e. either to 0...20 mA or to 4...20 mA.

Analogue inputs

Check the following variable for the digitized input values:

Inputs		
Variable	Data type	Explanation
AnalogInputn	INT	Value measured on channel n (n= 0...3)

Measured value

0-20 mA current mode	
Current [mA]	Value [hex]
0	0x0
10	0x7FFF
20	0xFFFF

4-20 mA current mode	
Current [mA]	Value [hex]
4	0x0
12	0x7FFF
20	0xFFFF

Measured & variable values and state of AI4-I 12BIT CoE

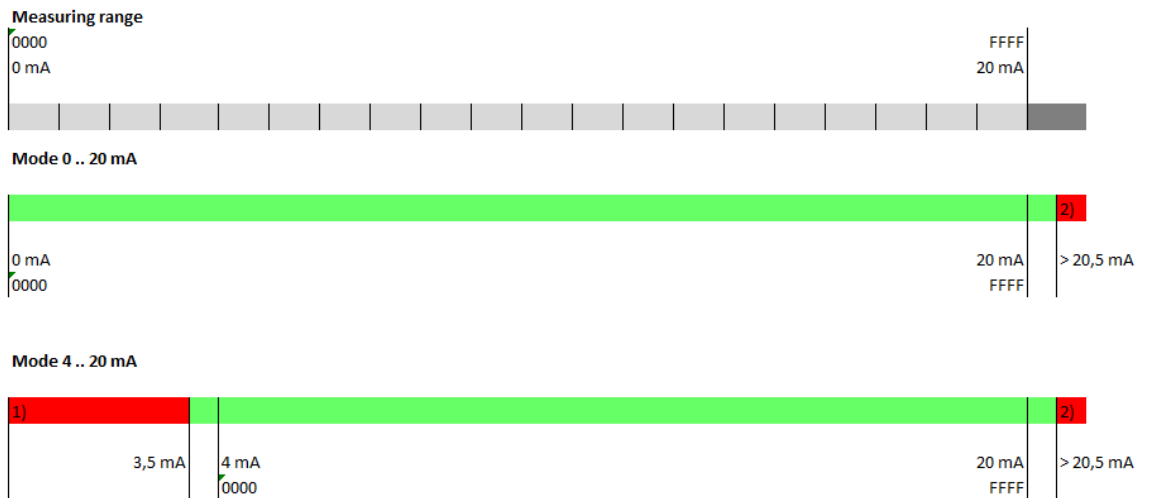

- 1) At a current of < 3.5 mA: EtherCat process image message "Input x low" and flash code at the input (red LED flashes 1x)
- 2) At a current of < 20.5 mA: EtherCat process image message "Input x high" and flash code at the input (red LED flashes 2x)

Figure 29: Values

Module options

Conversion of the analogue values can be synchronized with DC (Distributed Clocks) or SM (Sync Manager).

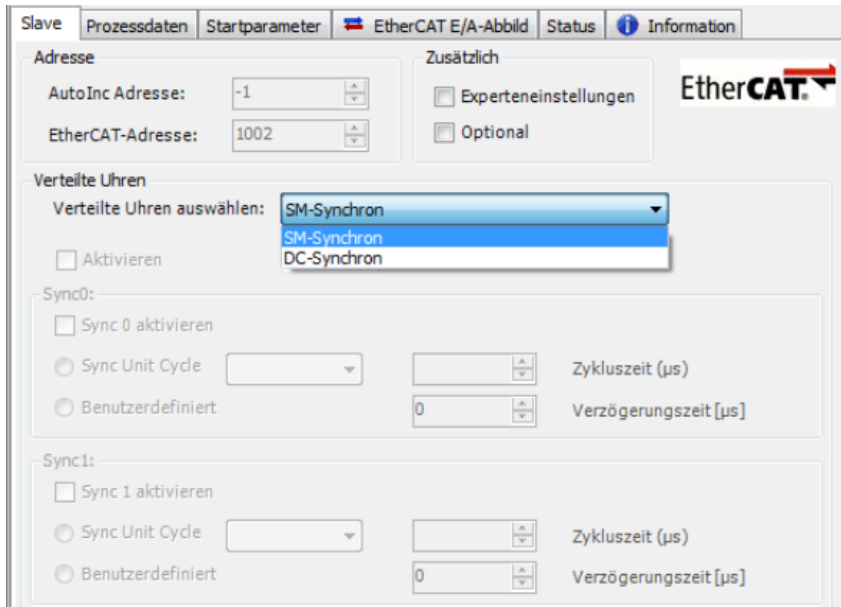

Figure 30: Module options

The process data objects stored as variables in the EtherCAT master's control program are used to access the input values and the module state.

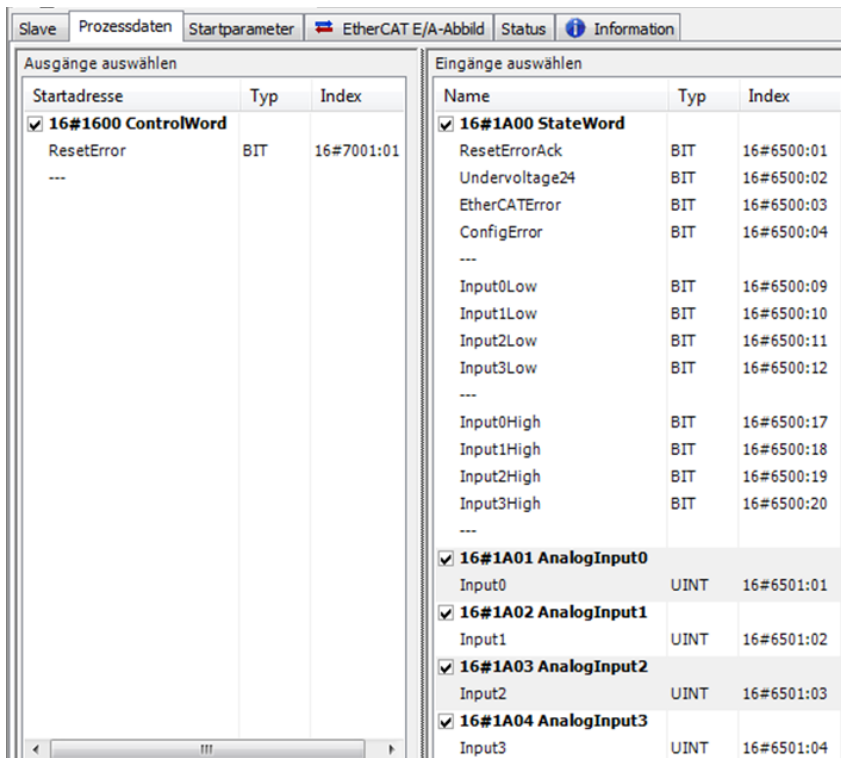

Figure 31: Process data

Service data objects (SDO) are available for details and settings.

You may run the configuration tool offline and choose the "Startup Parameters" to change some settings of AI4-I 12BIT CoE module (such as the properties of each of the inputs). The EtherCAT master will apply the settings when starting up the module.

You can also use the SDO transfer components available for the EtherCAT master to change settings at runtime.

Click/tap on "Add...", choose an object, and set the appropriate value.

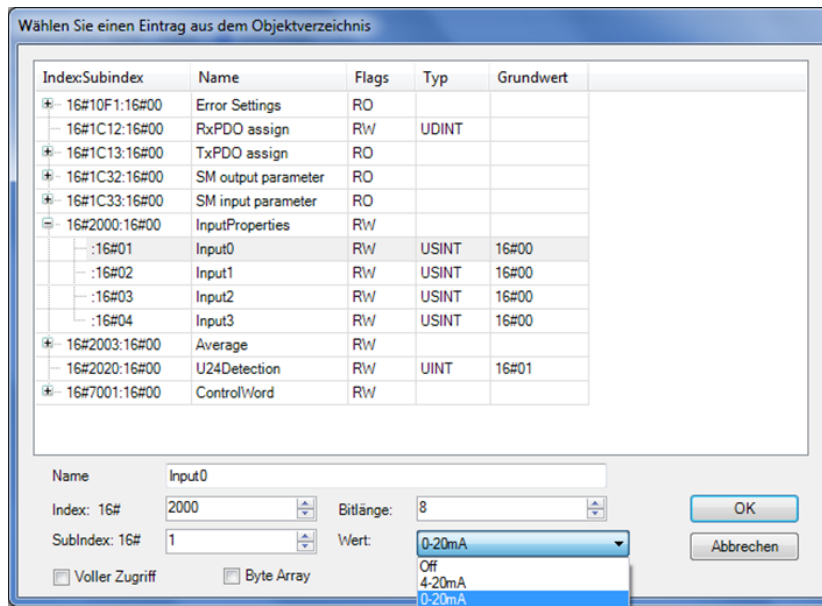

Figure 32: Object dictionary

You can set up the following options for every channel:

Module options		
Name	Value	Explanation
InputProperties	0	Off (default)
	5	4-20 mA
	6	0-20 mA
Average	n=1...255	Inputn=average after n cycles (default=1)

StateWord

The state word (DWORD) is indicative of the module state:

StateWord		
Bit	Name	Explanation
0	ResetErrorAck	Acknowledges "Reset Error" in Module Control
1	Undervoltage24	Power to passive sensors < 19 V (no error, just info)
2	EtherCATErrors	Sync Manager Watchdog
3	ConfigError	Mismatch of Sync Manager's quantity structure
4-7		not used
8	Input0low	Current at 4-20 mA < 3.5 mA
9	Input1low	Current at 4-20 mA < 3.5 mA
10	Input2low	Current at 4-20 mA < 3.5 mA
11	Input3low	Current at 4-20 mA < 3.5 mA
12-15		not used
16	Input0high	Current > 20.5 mA
17	Input1high	Current > 20.5 mA
18	Input2high	Current > 20.5 mA
19	Input3high	Current > 20.5 mA
20-31	-	not used

Analogue inputs

Check the following variables for the digitized input values:

Inputs		
Variable	Data type	Explanation
Inputn	INT	Value of channel n (n = 0...3)

ControlWord

The control word contains a bit for acknowledging errors.

ControlWord		
Bit	Name	Explanation
0	ResetError	0 -> errors are retained, 1 -> errors cleared after removing their cause
1-15	-	not used

Object dictionary

Index	Name	Type	Default	Min Max	Access
1000	Device Type	UINT32	0x40191		RO
1001	Error Register	UINT8			RO
1008	Device Name	String	AI4-I 12-Bit		RO
1009	Hardware Version	String	1.00		RO
100A	Software Version	String	1.00		RO
1018	Identity Object	Array			
1018, 0	Number of Entries	UINT8	4		RO
1018, 1	Vendor Id	UINT32	0x0048554B		RO
1018, 2	Product Code	UINT32	185339		RO
1018, 3	Revision Number	UINT32	1		RO
1018, 4	Serial Number	UINT32			RO
2000	Analog Input Properties	Array			
2000, 0	Number of Entries	UINT8	4		RO
2000, 1	Input 0	UINT8	Off	Off (0), 4-20mA (5), 0-20mA (6)	RW
2000, 2	Input 1	UINT8	Off	Off (0), 4-20mA (5), 0-20mA (6)	RW
2000, 3	Input 2	UINT8	Off	Off (0), 4-20mA (5), 0-20mA (6)	RW
2000, 4	Input 3	UINT8	Off	Off (0), 4-20mA (5), 0-20mA (6)	RW
2003	Input Average	Array			
2003, 0	Number of Entries	UINT8	4		RO
2003, 1	Input 0 Average	UINT8	1	1..255	RW
2003, 2	Input 1 Average	UINT8	1	1..255	RW
2003, 3	Input 2 Average	UINT8	1	1..255	RW
2003, 4	Input 3 Average	UINT8	1	1..255	RW
6401	Analogue input	Array			
6401, 0	Number of Entries	UINT8	4		RO
6401, 1	Analog Input 0	UINT16			RO P
6401, 2	Analog Input 1	UINT16			RO P
6401, 3	Analog Input 2	UINT16			RO P
6401, 4	Analog Input 3	UINT16			RO P
6500	StateWord	Array			
6500, 0	Number of Entries	UINT8	32		RO
6500, 1	ResetErrorAck	BOOL			RO P
6500, 2	Undervoltage24	BOOL			RO P
6500, 3	EtherCAT Error	BOOL			RO P
6500, 4	ConfigError	BOOL			RO P
6500, 5..8	-	BOOL			RO P

Index	Name	Type	Default	Min Max	Access
6500, 9	Input 0 low	BOOL			RO P
6500, 10	Input 1 low	BOOL			RO P
6500, 11	Input 2 low	BOOL			RO P
6500, 12	Input 3 low	BOOL			RO P
6500, 13..16	-	BOOL			RO P
6500, 17	Input 0 high	BOOL			RO P
6500, 18	Input 1 high	BOOL			RO P
6500, 19	Input 2 high	BOOL			RO P
6500, 20	Input 3 high	BOOL			RO P
6500, 21..32	-	BOOL			RO P
6500, 1	ResetErrorAck	BOOL			RO P
6500, 3	EtherCAT Error	BOOL			RO P
6500, 4	ConfigError	BOOL			RO P
7001	Module Control	Array			
7001, 0	Number of Entries	UINT8	1		RO
7001, 1	Reset Error	BOOL			RW P

RO=read-only, RW= read/write, P=process image

7.3.4. Technical data

AI4-I 12BIT CoE	
Label	MC-I/O AI4-I 12BIT CoE
Part no.	S-01030202-0100
Plug-in connector	18-pole S-02020201-0800 (not part of the module)
Analogue inputs	4
Resolution	12 bit
Measuring range	0 ... 20 mA, 4 ... 20 mA (final value: 20 mA)
Start AD conversion	synchronized with DC / SM
Conversion time	235 µs (if all channels are enabled)
Input filter cutoff frequency	100 kHz
Measuring error	< ±0,5 %, typ. < ±0,4 % of final value
Internal resistance	< 300 Ω
Controller	ASIC ET1200
Baud rate	100 Mbit/s
E-bus port	10-pin system plug in side wall
Term. module	not required
Power supply	24 V DC -20 % +25 %
E-bus load	190 mA
UL approval	

7.4. Analogue inputs for current measurement AI8-I 12BIT CoE

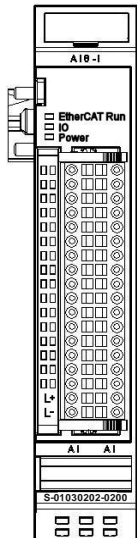

Figure 33: Front view of AI8-I 12BIT CoE I/O module

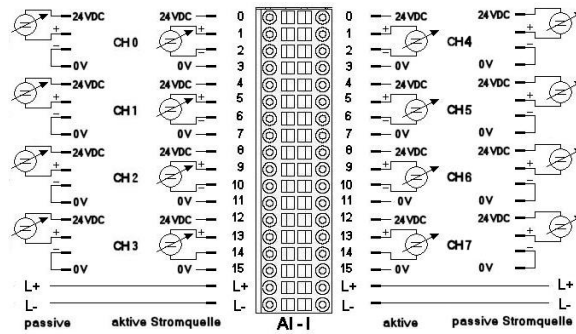

Figure 34: I/O connection

i NOTE

The AI8-I 12BIT CoE module is the successor module NOT compatible with the AI8-I module.

Before replacing an AI8-I module with an AI8-I 12BIT CoE module, you must modify the EtherCAT master's control program.

7.4.1. Terminals

The 24 V connector supplies power to the sensors. Power is supplied to the module through the E-bus connector.

Operative earth / shielding of analogue wires □ section 3.1.1 Earth

7.4.2. Status LEDs

“EtherCAT” LED

The LED labeled “EtherCAT” indicates the state of the EtherCAT ASIC.

EtherCAT		
State	LED flash code	Explanation
Init	Red, on	Initializing, no data exchange
Pre-Op	Red/green, 1:1	Pre-operational, no data exchange
Safe-Op	Red/green, 5:1	Safe operation, inputs readable
Op	Green, on	Operational, unrestricted data exchange

“I/O” LED

The LED labeled “I/O” indicates the state of the module's I/Os.

I/O		
State	LED flash code	Explanation
Ok	Green, on	No error
Error	Off	Malfunction of module if E-bus LED = On
		Inoperative if E-bus LED = Off
	Red, 4x	EtherCAT watchdog control
	Red, 7x	Configuration error (E-bus pre-operational), no. of process data differs from that in the module
Defective	Red, on	Module defective

“Power” LED

The LED labeled "Power" indicates the state of the power supplied to the I/O module's I/O sensors.

Power		
State	LED flash code	Explanation
On	Green, on	24 V DC supply ok
Off	Off	24 V DC supply not ok

“Channel” LEDs

The "Channel" LEDs indicate the state of every channel.

Channel		
State	LED flash code	Explanation
On	Green, on	Channel enabled
Off	Off	Channel disabled
Error	Red, 1x	Current > 20.5 mA
	Red, 2x	Current < 3.5 mA (4...20 mA mode)

7.4.3. Function

The AI8-I 12BIT CoE module has 8 analogue current signal inputs. Their measuring range can be set separately for every channel, i.e. either to 0...20 mA or to 4...20 mA.

Analogue inputs

Check the following variable for the digitized input values:

Inputs		
Variable	Data type	Explanation
AnalogInputn	INT	Value measured on channel n (n= 0...7)

Measured value

0-20 mA current mode	
Current [mA]	Value [hex]
0	0x0
10	0x7FFF
20	0xFFFF

4-20 mA current mode	
Current [mA]	Value [hex]
4	0x0
12	0x7FFF
20	0xFFFF

Measured & variable values and state of AI8-I 12BIT CoE

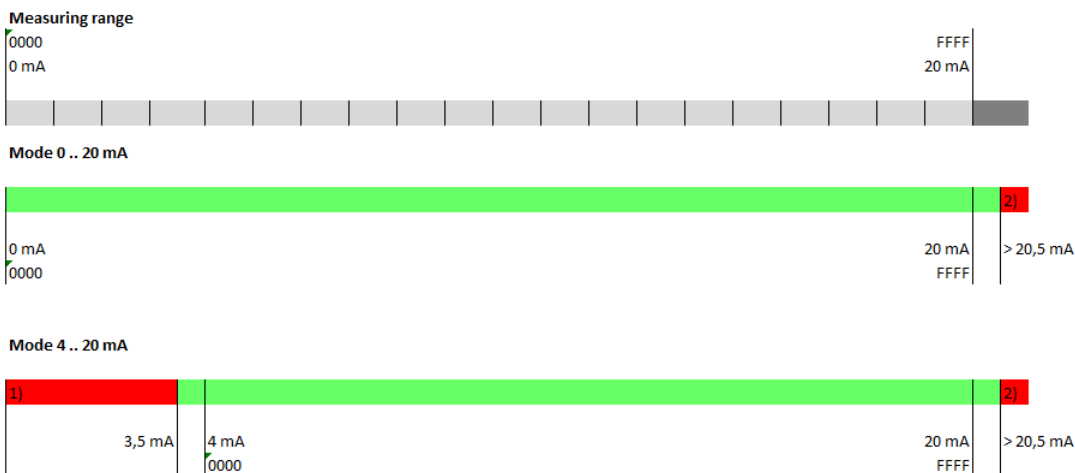

- 1) At a current of < 3.5 mA: EtherCat process image message "Input x low" and flash code at the input (red LED flashes 1x)
- 2) At a current of < 20.5 mA: EtherCat process image message "Input x high" and flash code at the input (red LED flashes 2x)

Figure 35: Measured values

Module options

Conversion of the analogue values can be synchronized with DC (Distributed Clocks) or SM (Sync Manager).

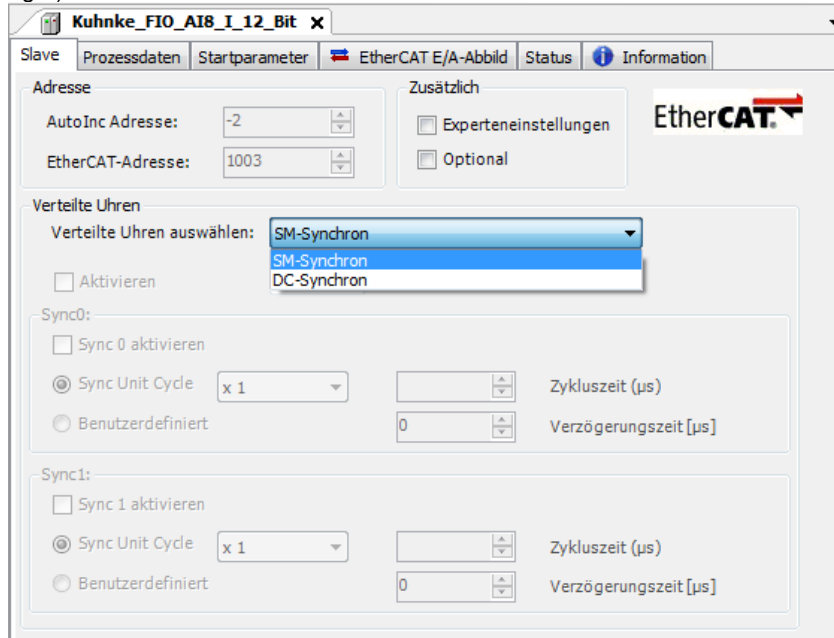

Figure 36: Module options

The process data objects stored as variables in the EtherCAT master's control program are used to access the input values and the module state.

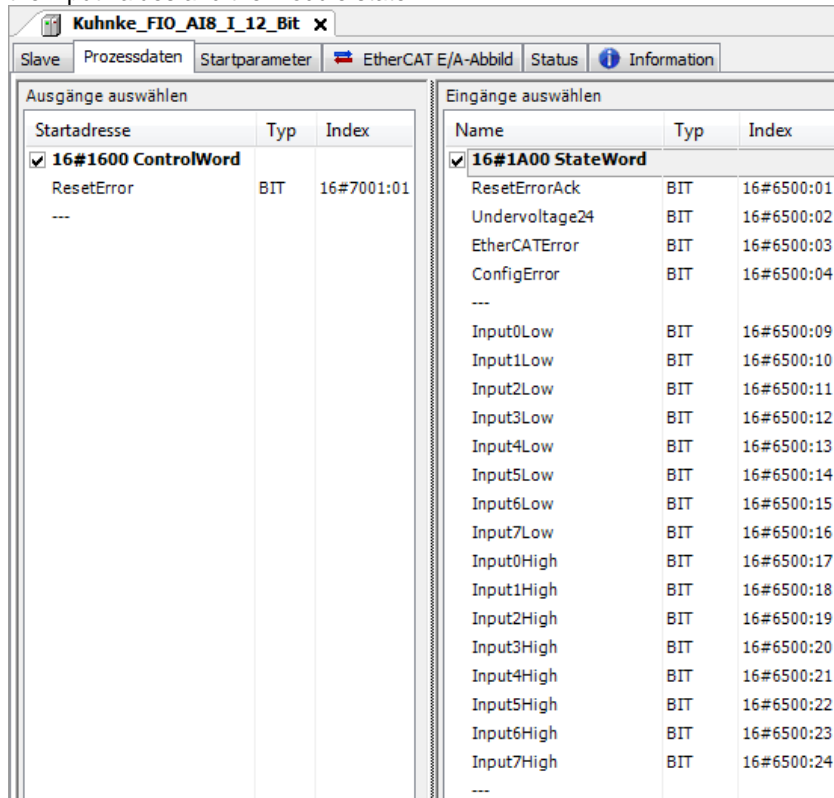

Figure 37: Process data

Service data objects (SDO) are available for details and settings.

You may run the configuration tool offline and choose the "Startup Parameters" to change some settings of AI8-I 12BIT CoE module (such as the properties of each of the inputs). The EtherCAT master will apply the settings when starting up the module.

You can also use the SDO transfer components available for the EtherCAT master to change settings at runtime.

Click/tap on "Add...", choose an object, and set the appropriate value.

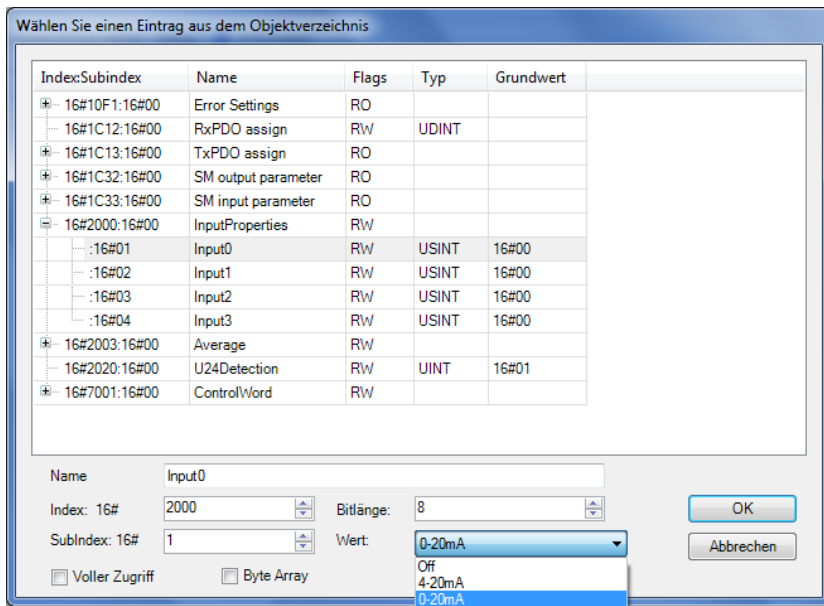

Figure 38: Object dictionary

You can set up the following options for every channel:

Module options		
Name	Value	Explanation
InputProperties	0	Off (default)
	5	4-20 mA
	6	0-20 mA
Average	n=1...255	Inputn=average after n cycles (default=1)

StateWord

The state word (DWORD) is indicative of the module state:

StateWord		
Bit	Name	Explanation
0	ResetErrorAck	Acknowledges "Reset Error" in Module Control
1	Undervoltage24	Power to passive sensors < 19 V (no error, just info)
2	EtherCATError	Sync Manager Watchdog
3	ConfigError	Mismatch of Sync Manager's quantity structure
4-7		not used
8	Input0low	Current at 4-20 mA < 3.5 mA
9	Input1low	Current at 4-20 mA < 3.5 mA
10	Input2low	Current at 4-20 mA < 3.5 mA
11	Input3low	Current at 4-20 mA < 3.5 mA
12	Input4low	Current at 4-20 mA < 3.5 mA
13	Input5low	Current at 4-20 mA < 3.5 mA
14	Input6low	Current at 4-20 mA < 3.5 mA
15	Input7low	Current at 4-20 mA < 3.5 mA
16	Input0high	Current > 20.5 mA
17	Input1high	Current > 20.5 mA
18	Input2high	Current > 20.5 mA
19	Input3high	Current > 20.5 mA
20	Input4high	Current > 20.5 mA
21	Input5high	Current > 20.5 mA
22	Input6high	Current > 20.5 mA
23	Input7high	Current > 20.5 mA
24-31	-	not used

Analogue inputs

Check the following variables for the digitized input values:

Inputs		
Variable	Data type	Explanation
Inputn	INT	Value of channel n (n = 0...7)

ControlWord

The control word contains a bit for acknowledging errors.

ControlWord		
Bit	Name	Explanation
0	ResetError	0 -> errors are retained, 1 -> errors cleared after removing their cause
1-15	-	not used

Object dictionary

Index	Name	Type	Default	Min Max	Access
1000	Device Type	UINT32	0x40191		RO
1001	Error Register	UINT8			RO
1008	Device Name	String	A18-I 12-Bit		RO
1009	Hardware Version	String	1.00		RO
100A	Software Version	String	1.00		RO
1018	Identity Object	Array			
1018, 0	Number of Entries	UINT8	4		RO
1018, 1	Vendor Id	UINT32	0x0048554B		RO
1018, 2	Product Code	UINT32	185345		RO
1018, 3	Revision Number	UINT32	1		RO
1018, 4	Serial Number	UINT32			RO
2000	Analog Input Properties	Array			
2000, 0	Number of Entries	UINT8	8		RO
2000, 1	Input 0	UINT8	Off	Off (0), 4-20mA (5), 0-20mA (6)	RW
2000, 2	Input 1	UINT8	Off	Off (0), 4-20mA (5), 0-20mA (6)	RW
2000, 3	Input 2	UINT8	Off	Off (0), 4-20mA (5), 0-20mA (6)	RW
2000, 4	Input 3	UINT8	Off	Off (0), 4-20mA (5), 0-20mA (6)	RW
2000, 5	Input 4	UINT8	Off	Off (0), 4-20mA (5), 0-20mA (6)	RW
2000, 6	Input 5	UINT8	Off	Off (0), 4-20mA (5), 0-20mA (6)	RW
2000, 7	Input 6	UINT8	Off	Off (0), 4-20mA (5), 0-20mA (6)	RW

Index	Name	Type	Default	Min Max	Access
2000, 8	Input 7	UINT8	Off	Off (0), 4-20mA (5), 0-20mA (6)	RW
2003	Input Average	Array			
2003, 0	Number of Entries	UINT8	8		RO
2003, 1	Input 0 Average	UINT8	1	1..255	RW
2003, 2	Input 1 Average	UINT8	1	1..255	RW
2003, 3	Input 2 Average	UINT8	1	1..255	RW
2003, 4	Input 3 Average	UINT8	1	1..255	RW
2003, 5	Input 4 Average	UINT8	1	1..255	RW
2003, 6	Input 5 Average	UINT8	1	1..255	RW
2003, 7	Input 6 Average	UINT8	1	1..255	RW
2003, 8	Input 7 Average	UINT8	1	1..255	RW
6401	Analogue input	Array			
6401, 0	Number of Entries	UINT8	8		RO
6401, 1	Analog Input 0	UINT16			RO P
6401, 2	Analog Input 1	UINT16			RO P
6401, 3	Analog Input 2	UINT16			RO P
6401, 4	Analog Input 3	UINT16			RO P
6401, 5	Analog Input 4	UINT16			RO P
6401, 6	Analog Input 5	UINT16			RO P
6401, 7	Analog Input 6	UINT16			RO P
6401, 8	Analog Input 7	UINT16			RO P
6500	StateWord	Array			
6500, 0	Number of Entries	UINT8	32		RO
6500, 1	ResetErrorAck	BOOL			RO P
6500, 2	Undervoltage24	BOOL			RO P
6500, 3	EtherCAT Error	BOOL			RO P
6500, 4	ConfigError	BOOL			RO P
6500, 5..8	-	BOOL			RO P
6500, 9	Input 0 low	BOOL			RO P
6500, 10	Input 1 low	BOOL			RO P
6500, 11	Input 2 low	BOOL			RO P
6500, 12	Input 3 low	BOOL			RO P
6500, 13	Input 4 low	BOOL			RO P
6500, 14	Input 5 low	BOOL			RO P
6500, 15	Input 6 low	BOOL			RO P
6500, 16	Input 7 low	BOOL			RO P
6500, 17	Input 0 high	BOOL			RO P
6500, 18	Input 1 high	BOOL			RO P
6500, 19	Input 2 high	BOOL			RO P
6500, 20	Input 3 high	BOOL			RO P
6500, 21	Input 4 high	BOOL			RO P
6500, 22	Input 5 high	BOOL			RO P
6500, 23	Input 6 high	BOOL			RO P

Index	Name	Type	Default	Min Max	Access
6500, 24	Input 7 high	BOOL			RO P
6500, 25..32	-	BOOL			RO P
6500, 1	ResetErrorAck	BOOL			RO P
6500, 3	EtherCAT Error	BOOL			RO P
6500, 4	ConfigError	BOOL			RO P
7001	Module Control	Array			
7001, 0	Number of Entries	UINT8	1		RO
7001, 1	Reset Error	BOOL			RW P

RO=read-only, RW= read/write, P=process image

7.4.4. Technical data

AI8-I 12BIT CoE	
Label	MC-I/O AI8-I 12BIT CoE
Part no.	S-01030202-0200
Plug-in connector	36-pole S-02020201-0900 (not part of the module)
Analogue inputs	8
Resolution	12 bit
Measuring range	0 ... 20 mA, 4 ... 20 mA (final value: 20 mA)
Start AD conversion	synchronized with DC / SM
Conversion time	290 µs (if all channels are enabled)
Input filter cutoff frequency	100 kHz
Measuring error	< ±0,5 %, typ. < ±0,4 % of final value
Internal resistance	< 300 Ω
Controller	ASIC ET1200
Baud rate	100 Mbit/s
E-bus port	10-pin system plug in side wall
Term. module	not required
Power supply	24 V DC -20 % +25 %
E-bus load	190 mA
UL approval	

7.5. Analogue inputs for voltage measurement AI4/8-U

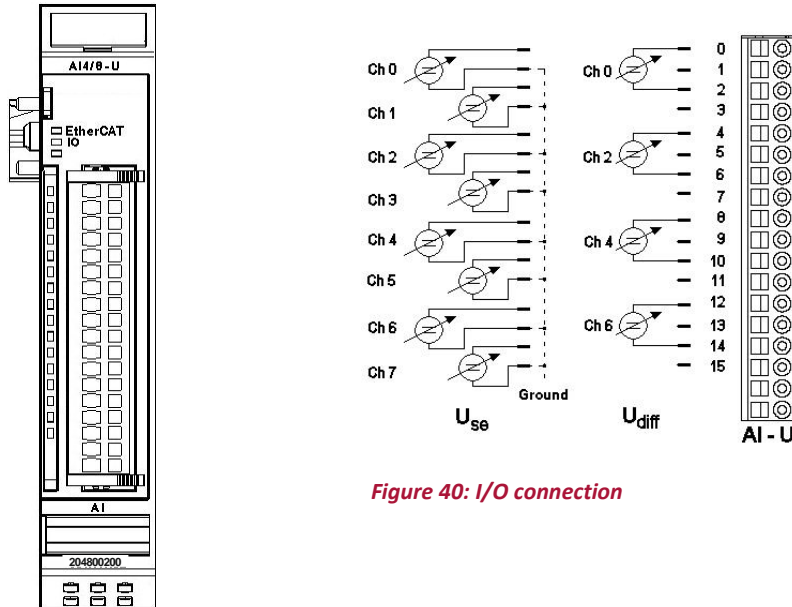

Figure 39: Front view of AI4/8-U I/O module

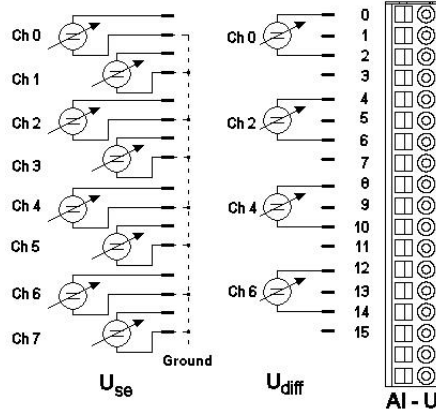

Figure 40: I/O connection

i NOTE

The AI4/8-U module is no longer recommended for new projects. Please use the successive AI4/8-U 13BIT CoE module.

7.5.1. Terminals

The module needs no separate 24 V connector. Power is supplied to the module through the E-bus connector.

Operative earth / shielding of analog wires □ section 3.1.1 Earth

7.5.2. Status LEDs

“EtherCAT” LED

The LED labeled “EtherCAT” indicates the state of the EtherCAT ASIC.

EtherCAT		
State	LED flash code	Explanation
Init	Red, on	Initializing, no data exchange
Pre-Op	Red/green, 1:1	Pre-operational, no data exchange
Safe-Op	Red/green, 5:1	Safe operation, inputs readable
Op	Green, on	Operational, unrestricted data exchange

“I/O” LED

The LED labeled “I/O” indicates the state of the module's I/Os.

I/O		
State	LED flash code	Explanation
Ok	Green, on	No error
Error	Off	Malfunction of module if E-bus LED = On Inoperative if E-bus LED = Off
	Red, 4x	EtherCAT watchdog control
	Red, 7x	Configuration error (E-bus pre-operational), no. of process data differs from that in the module
Defective	Red, on	Module defective

“Power” LED

There is no LED labeled “Power” because a separate power feed is not required.

“Channel” LEDs

Channel		
State	LED flash code	Explanation
On	Green, on	Channel enabled
Off	Off	Channel disabled

7.5.3. Function

The AI4/8-U module has 8 analogue inputs. If signal lines are single-ended (measured against earth, L-), 8 channels are available. To measure differential signals, you will need 2 channels for every signal, i.e. you can pick up no more than 4 differential signals. Channels can be combined as follows: 0/1, 2/3, 4/5 and 6/7.

Analogue inputs

Check the following variable for the digitized input values:

Inputs		
Variable	Data type	Explanation
Channel_n	INT	Value measured on channel n (n= 0...7)

Analogue values voltage

Measuring	Variable value (for 16 bit)					
	bipolar			unipolar		
volt	decimal	CODESYS (INT)	hexadecimal	decimal	CODESYS (INT)	hexadecimal
-10	32768	-32768	16#8000			
-9	36044	-29492	16#8CCC			
-8	39321	-26215	16#9999			
-7	42598	-22938	16#A666			
-6	45875	-19661	16#B333			
-5	49152	-16384	16#C000			
-4	52428	-13108	16#CCCC			
-3	55705	-9831	16#D999			
-2	58982	-6554	16#E666			
-1	62244	-3292	16#F324			
0	0	0	0	0	0	0
1	3276	3276	16#0CCC	6553	6553	16#1999
2	6553	6553	16#1999	13107	13107	16#3332
3	9830	9830	16#2666	19660	19660	16#4CCC
4	13106	13106	16#3332	26214	26214	16#6665
5	16383	16383	16#3FFF	32767	32767	16#7FFF
6	19660	19660	16#4CCC	39320	-26216	16#9998
7	22936	22936	16#5998	45874	-19662	16#B332

8	26213	26213	16#6665	52427	-13109	16#CCCB
9	29490	29490	16#7332	58981	-6555	16#E665
10	32767	32767	16#7FFF	65534	-2	16#FFFE

Module control

The module provides you with various operational options.

To set up the module choose the options as appropriate and accept by setting control bit “SetOptions” to a rising edge. The module will confirm by returning “OptionsSet”.

There are various “module error” bits that the module uses to indicate errors. The states of the error bits are retained and also used for error indication by the “I/O” LED. To reset the error bits set control bit “ResetError” to a rising edge.

Error bits		
Variable	Data type	Explanation
SetOptions	BOOL	Rising edge <input type="checkbox"/> accepts module options
ResetError	BOOL	Rising edge <input type="checkbox"/> acknowledges error

Module options

The following options are available for module AI4/8-U:

Module options		
Variable	Data type	Explanation
Channel_n_n+1_Differential	BOOL	The difference in voltages of channel n and channel n+1 is measured and output to channel n.
Channel_n_On	BOOL	Enable channel n
Channel_n_Unipolar	BOOL	Change measuring range of channel n from bipolar +10 V ... -10 V to unipolar 0... 10 V (doubles the resolution)
Channel_n_Filter	USINT	Filter on channel n New values avail. in k/3 ms (k=0..255)
n		0 ... 7 Channel number

To set and accept options, see Module control

Module state

The following states are indicated:

Module state		
Variable	Data type	Explanation
Shortcut	BOOL	Not used
Undervoltage	BOOL	Not used
Watchdog	BOOL	Internal watchdog of module
EtherCAT_Error	BOOL	Configuration error or watchdog control
Specific_Error	BOOL	Module-specific fault
OptionsSet	BOOL	Sent by module to acknowledge SetOptions

To reset the messages, see Module control

Module-specific messages

There are no module-specific messages for this module.

Conversion time

The analogue signals are converted one by one down every channel. Disabling one or several channels will shorten the entire A/D conversion cycle.

“Filter” in this case means to compute an average when the set filter time is over.

Analogue value conversion runs cyclically and is not synchronized with the receipt of EtherCAT telegrams. The cycle consists of the analogue value conversion plus transmitting the values into the EtherCAT data area.

Conversion time			
Number of channels	Cycle time in ms (all filters=0)	Number of channels	Cycle time in ms (all filters=0)
1	270 µs	5	630 µs
2	360 µs	6	710 µs
3	450 µs	7	800 µs
4	540 µs	8	890 µs

i NOTE

If you are aiming for a high sampling frequency, the EtherCAT master should do the filtering (averaging) because it will normally have much more processing power.

i NOTE

Take the EtherCAT cycle into account to assess how much the values stored by the EtherCAT master are up-to-date. The module described in this section will accept the above times as the ideal EtherCAT cycle setup.

Quality of analogue values**i NOTE**

Best results are obtained by

- connecting the shield of the signal cables to operative earth
- connecting unused single-ended lines to Ground
- short-circuiting unused differential inputs

7.5.4. Technical data

AI4/8-U	
Label	MC-I/O AI4/8-U 13BIT
Part no.	204800200
Plug-in connector	18-pole S-02020201-0800 (not part of the module)
Analogue inputs	8 single ended or 4 differential
Resolution	13 Bit (1.221 μ V unipolar, 2.442 μ V bipolar)
Measuring range	0 ... 10 V, \pm 10 V
Temperature drift	< -15 ppm/ $^{\circ}$ C regarding range limit
Critical frequency	typical 1 MHz
Input resistance	> 100 M Ω
Sampling frequency	1.12 kHz (if all channels are enabled)
Controller	ASIC ET1200
Baud rate	100 Mbit/s
E-bus port	10-pin system plug in side wall
Term. module	not required
Power supply	from coupler through E-bus connector
E-bus load	190 mA
UL approval	 <p>UL LISTED 59DM E242595 IND.CONT.EQ.</p>

7.6. Analogue inputs for voltage measurement AI4/8-U 13BIT CoE

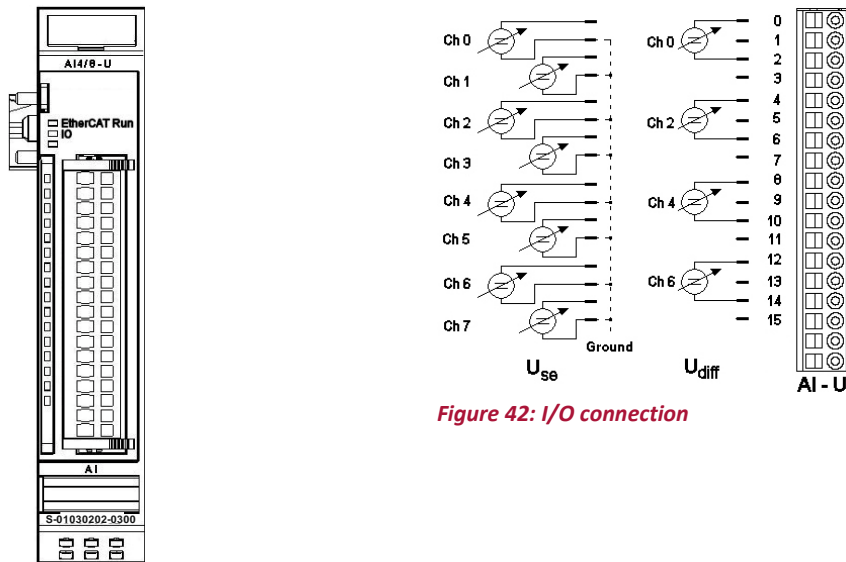

Figure 41: Front view of AI4/8-U 13BIT CoE I/O module

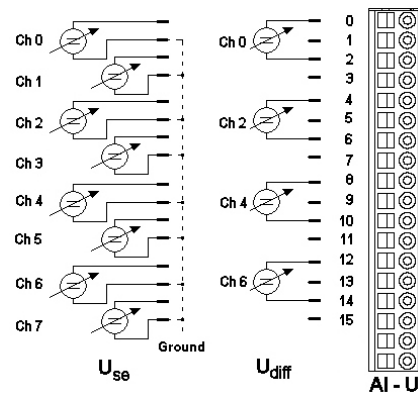

Figure 42: I/O connection

NOTE

The AI4/8-U 13BIT CoE module is the successor module NOT compatible with the AI8-I module. Before replacing an AI4/8-U module with an AI4/8-U 13BIT CoE module, you must modify the EtherCAT master's control program.

7.6.1. Terminals

The module needs no separate 24 V connector. Power is supplied to the module through the E-bus connector.

Operative earth / shielding of analogue wires □ section 3.1.1 Earth

7.6.2. Status LEDs

“EtherCAT” LED

The LED labeled “EtherCAT” indicates the state of the EtherCAT ASIC.

EtherCAT		
State	LED flash code	Explanation
Init	Red, on	Initializing, no data exchange
Pre-Op	Red/green, 1:1	Pre-operational, no data exchange
Safe-Op	Red/green, 5:1	Safe operation, inputs readable
Op	Green, on	Operational, unrestricted data exchange

“I/O” LED

The LED labeled “I/O” indicates the state of the module’s I/Os.

I/O		
State	LED flash code	Explanation
Ok	Green, on	No error
Error	Off	Malfunction of module if E-bus LED = On
		Inoperative if E-bus LED = Off
	Red, 4x	EtherCAT watchdog control
	Red, 7x	Configuration error (E-bus pre-operational), no. of process data differs from that in the module
Defective	Red, on	Module defective

“Power” LED

There is no LED labeled “Power” because a separate power feed is not required.

“Channel” LEDs

The "Channel" LEDs indicate the state of every channel.

Channel		
State	LED flash code	Explanation
On	Green, on	Channel enabled
Off	Off	Channel disabled

7.6.3. Function

The AI4/8-U 13BIT CoE module has 8 analogue inputs. If signal lines are single-ended (measured against earth, L-), 8 channels are available. To measure differential signals, you will need 2 channels for every signal, i.e. you can pick up no more than 4 differential signals. Channels can be combined as follows: 0/1, 2/3, 4/5 and 6/7.

Analogue voltage values

Measured value			Variable value (@ 16 bits)			
±10 V	±5 V	±2,5 V	Bipolar		Unipolar [UINT*]	
Volt	Volt	Volt	Decimal	Hexadecimal	Decimal	Hexadecimal
-10	-5	-2.5	-32768	16#8000		
-9	-4.5	-2.25	-29492	16#8CCC		
-8	-4	-2	-26215	16#9999		
-7	-3.5	-1.75	-22938	16#A666		
-6	-3	-1.5	-19661	16#B333		
-5	-2.5	-1.25	-16384	16#C000		
-4	-2	-1	-13108	16#CCCC		
-3	-1.5	-0.75	-9831	16#D999		
-2	-1	-0.5	-6574	16#E666		
-1	-0.5	-0.25	-3292	16#F324		
0	0	0	0	0	0	0
1	0.5	0.25	3276	16#0CCC	6553	16#1999
2	1	0.5	6553	16#1999	13107	16#3332
3	1.5	0.75	9830	16#2666	19660	16#4CCC
4	2	1	13106	16#3332	26214	16#6665
5	2.5	1.25	16383	16#3FFF	32767	16#7FFF
6	3	1.5	19660	16#4CCC	39320	16#9998
7	3.5	1.75	22936	16#5998	45874	16#B332
8	4	2	26213	16#6665	52427	16#CCCB
9	4.5	2.25	29490	16#7332	58981	16#E665
10	5	2.5	32767	16#7FFF	65534	16#FFFE

*Data type conversion required

i NOTE

If the inputs are not used but switched on, the measured values displayed in the I / O image are floated. To prevent this, you should deactivate the measurement channel at the start parameters or set the input to ground (short-circuit when measuring differential signals).

Module options

Conversion of the analogue values can be synchronized with DC (Distributed Clocks) or SM (Sync Manager).

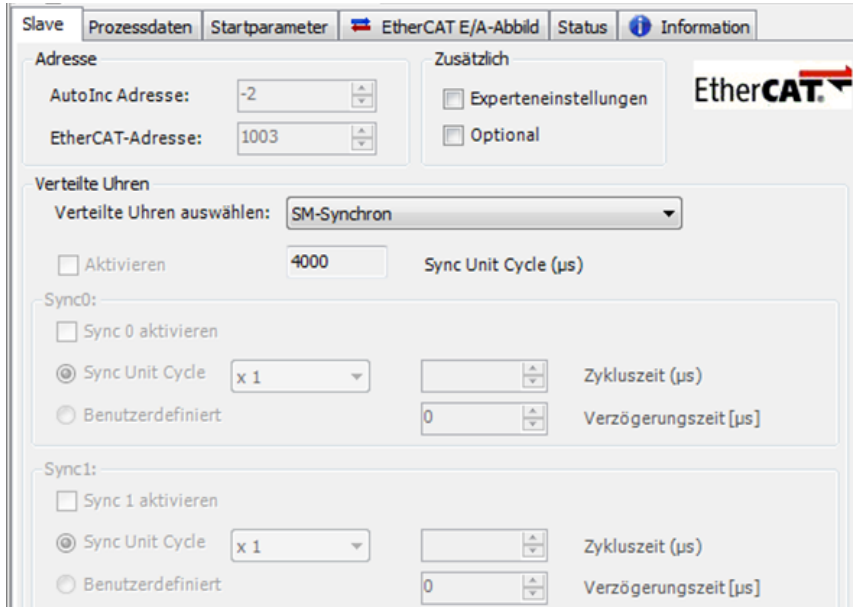

Figure 43: Module options

The process data objects stored as variables in the EtherCAT master's control program are used to access the input values and the module state.

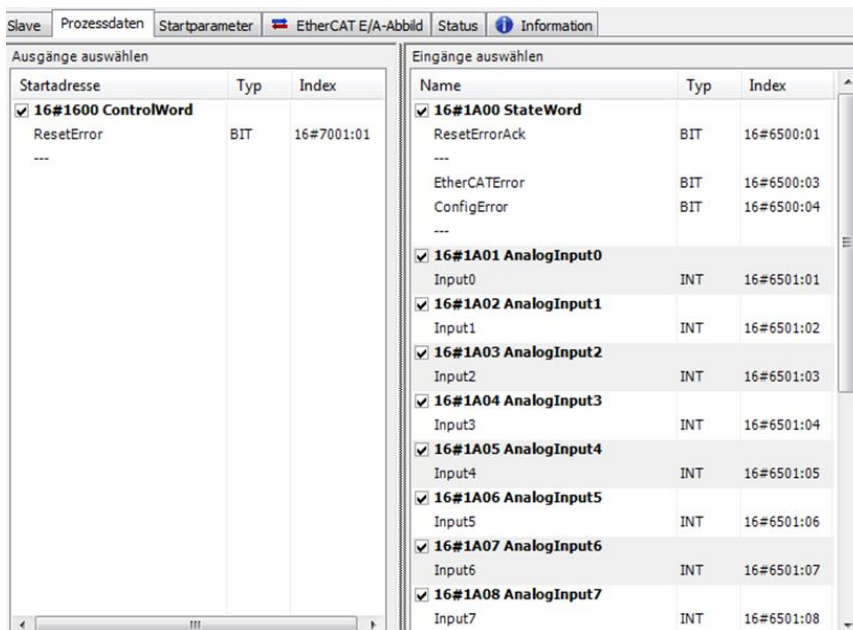

Figure 44: Process data

Service data objects (SDO) are available for details and settings.

You may run the configuration tool offline and choose the "Startup Parameters" to change some settings of AI4/8-U 13BIT CoE module (such as the properties of each of the inputs). The EtherCAT master will apply the settings when starting up the module.

You can also use the SDO transfer components available for the EtherCAT master to change settings at runtime.

Click/tap on "Add...", choose an object, and set the appropriate value.

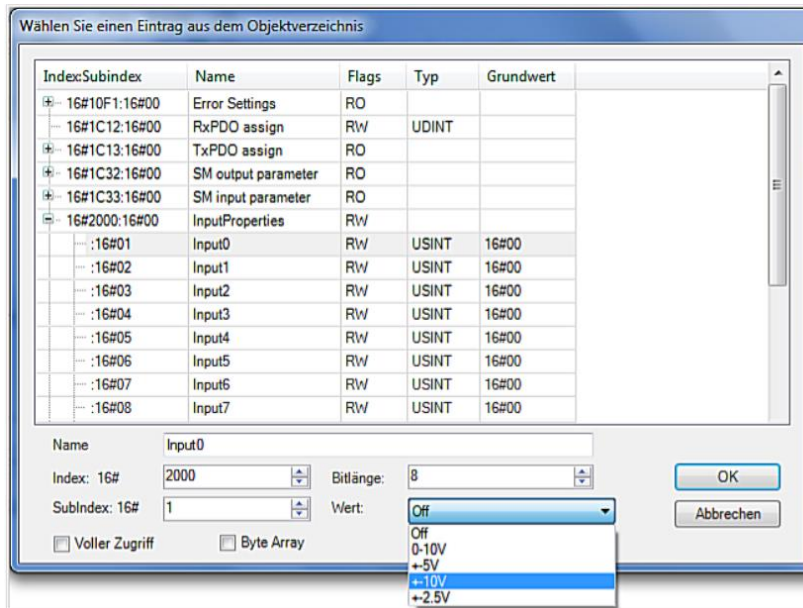

Figure 45: Object dictionary

You can set up the following options:

Module options		
Name	Value	Explanation
InputProperties	0	Off (default)
	1	0-10 V
	2	±5 V
	3	±10 V
	4	±2.5 V
InputSwitch	0	Single-Ended (default)
	1	Differential
Average	n=1...255	Inputn=average after n cycles (default=1)

StateWord

The state word is indicative of the module state:

StateWord		
Bit	Name	Bedeutung
0	ResetErrorAck	Acknowledges "Reset Error" in Module Control
1		not used
2	EtherCATErrror	Sync Manager Watchdog
3	ConfigError	Mismatch of Sync Manager's quantity structure
4-15		not used

Analogue inputs

Check the following variables for the digitized input values:

Inputs		
Variable	Data type	Explanation
Inputn	INT	Value of channel n (n= 0...7)

ControlWord

The control word contains a bit for acknowledging errors.

ControlWord		
Bit	Name	Explanation
0	ResetError	0 -> errors are retained, 1 -> errors cleared after removing their cause
1-15	-	not used

Object dictionary

Index	Name	Type	Default	Min Max	Access
1000	Device Type	UINT32	0x40191		RO
1001	Error Register	UINT8			RO
1008	Device Name	String	A14/8-U 13-Bit		RO
1009	Hardware Version	String	1.00		RO
100A	Software Version	String	1.00		RO
1018	Identity Object	Array			
1018, 0	Number of Entries	UINT8	4		RO
1018, 1	Vendor Id	UINT32	0x0048554B		RO
1018, 2	Product Code	UINT32	185340		RO

Index	Name	Type	Default	Min Max	Access
1018, 3	Revision Number	UINT32	2		RO
1018, 4	Serial Number	UINT32	0		RO
2000	Analog Input Properties	Array			
2000, 0	Number of Entries	UINT8	8		RO
2000, 1	Input 0	UINT8	Off	Off (0), 0-10V (1), +-5V (2) +-10V (3) +-2.5V (4)	RW
2000, 2	Input 1	UINT8	Off	Off (0), 0-10V (1), +-5V (2) +-10V (3) +-2.5V (4)	RW
2000, 3	Input 2	UINT8	Off	Off (0), 0-10V (1), +-5V (2) +-10V (3) +-2.5V (4)	RW
2000, 4	Input 3	UINT8	Off	Off (0), 0-10V (1), +-5V (2) +-10V (3) +-2.5V (4)	RW
2000, 5	Input 4	UINT8	Off	Off (0), 0-10V (1), +-5V (2) +-10V (3) +-2.5V (4)	RW
2000, 6	Input 5	UINT8	Off	Off (0), 0-10V (1), +-5V (2) +-10V (3) +-2.5V (4)	RW
2000, 7	Input 6	UINT8	Off	Off (0), 0-10V (1), +-5V (2) +-10V (3) +-2.5V (4)	RW
2000, 8	Input 7	UINT8	Off	Off (0), 0-10V (1), +-5V (2) +-10V (3) +-2.5V (4)	RW
2001	Input Switch	Array			
2001, 0	Number of Entries	UINT8	4		RO
2001, 1	Input 0_1 Switch	UINT8	Single-ended	Single-ended (0) Differential (1)	RW
2001, 2	Input 2_3 Switch	UINT8	Single-ended	Single-ended (0)	RW

Index	Name	Type	Default	Min Max	Access
				Differential (1)	
2001, 3	Input 4_5 Switch	UINT8	Single-ended	Single-ended (0)	RW
				Differential (1)	
2001, 4	Input 6_7 Switch	UINT8	Single-ended	Single-ended (0)	RW
				Differential (1)	
2003	Input Filter	Array			
2003, 0	Number of Entries	UINT8	8		RO
2003, 1	Input 0 Average	UINT8	1	1..255	RW
2003, 2	Input 1 Average	UINT8	1	1..255	RW
2003, 3	Input 2 Average	UINT8	1	1..255	RW
2003, 4	Input 3 Average	UINT8	1	1..255	RW
2003, 5	Input 4 Average	UINT8	1	1..255	RW
2003, 6	Input 5 Average	UINT8	1	1..255	RW
2003, 7	Input 6 Average	UINT8	1	1..255	RW
2003, 8	Input 7 Average	UINT8	1	1..255	RW
6401	Analogue input	Array			
6401, 0	Number of Entries	UINT8	8		RO
6401, 1	Analog Input 0	UINT16			RO P
6401, 2	Analog Input 1	UINT16			RO P
6401, 3	Analog Input 2	UINT16			RO P
6401, 4	Analog Input 3	UINT16			RO P
6401, 5	Analog Input 4	UINT16			RO P
6401, 6	Analog Input 5	UINT16			RO P
6401, 7	Analog Input 6	UINT16			RO P
6401, 8	Analog Input 7	UINT16			RO P
6500	StateWord	Array			
6500, 0	Number of Entries	UINT8	16		RO
6500, 1	ResetErrorAck	BOOL			RO P
6500, 3	EtherCAT Error	BOOL			RO P
6500, 4	ConfigError	BOOL			RO P
7001	Module Control	Array			
7001, 0	Number of Entries	UINT8	1		RO
7001, 1	Reset Error	BOOL			RW P

RO=read-only, RW= read/write, P=process image

7.6.4. Technical data

AI4/8-U 13BIT CoE	
Label	MC-I/O AI4/8-U 13BIT CoE
Part no.	S-01030202-0300
Plug-in connector	18-pole S-02020201-0800 (not part of the module)
Analogue inputs	8 single ended or 4 differential
Resolution	13 bit
Measuring range	0 ... 10 V, ± 5 V, ± 10 V, $\pm 2,5$ V
Start AD conversion	synchronized with DC / SM
Conversion time	464 μ s (if all channels are enabled)
Input filter cutoff frequency	typ. 1 kHz
Measuring error	$< \pm 0,4$ %, typ. $< \pm 0,2$ % of final value
Internal resistance	> 1 M Ω
Controller	ASIC ET1200
Baud rate	100 Mbit/s
E-bus port	10-pin system plug in side wall
Term. module	not required
Power supply	24 V DC -20 % +25 %
E-bus load	190 mA
UL approval	

7.7. Analogue inputs for voltage measurement AI8/16-U 13BIT CoE

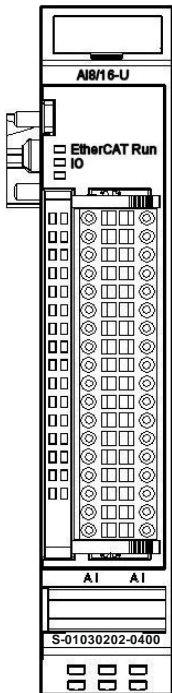

Figure 46: Front view of AI8/16-U 13BIT CoE I/O module

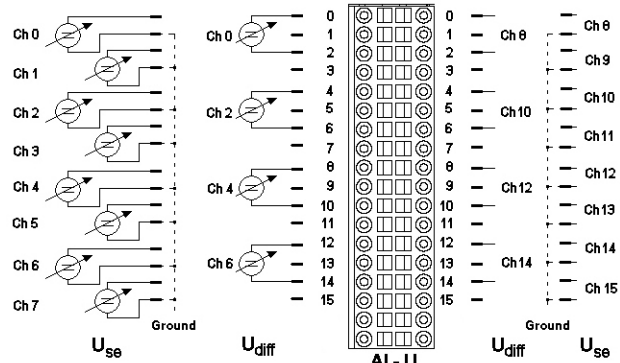

Figure 47: I/O connection

7.7.1. Terminals

The module needs no separate 24 V connector. Power is supplied to the module through the E-bus connector.

Operative earth / shielding of analogue wires □ section 3.1.1 Earth

7.7.2. Status LEDs

“EtherCAT” LED

The LED labeled “EtherCAT” indicates the state of the EtherCAT ASIC.

EtherCAT		
State	LED flash code	Explanation
Init	Red, on	Initializing, no data exchange
Pre-Op	Red/green, 1:1	Pre-operational, no data exchange
Safe-Op	Red/green, 5:1	Safe operation, inputs readable
Op	Green, on	Operational, unrestricted data exchange

“I/O” LED

The LED labeled “I/O” indicates the state of the module's I/Os.

I/O		
State	LED flash code	Explanation
Ok	Green, on	No error
Error	Off	Malfunction of module if E-bus LED = On
		Inoperative if E-bus LED = Off
	Red, 4x	EtherCAT watchdog control
	Red, 7x	Configuration error (E-bus pre-operational), no. of process data differs from that in the module
Defective	Red, on	Module defective

“Power” LED

There is no LED labeled “Power” because a separate power feed is not required.

“Channel” LEDs

The "Channel" LEDs indicate the state of every channel.

Channel		
State	LED flash code	Explanation
On	Green, on	Channel enabled
Off	Off	Channel disabled

7.7.3. Function

The AI8/16-U 13BIT CoE module has 16 analogue inputs. If signal lines are single-ended (measured against earth, L-), 16 channels are available. To measure differential signals, you will need 2 channels for every signal, i.e. you can pick up no more than 8 differential signals. Channels can be combined as follows: 0/1, 2/3, 4/5, 6/7, 8/9, 10/11, 12/13 and 14/15.

Analogue voltage values

Measured value			Variable value (@ 16 bits)			
±10 V	±5 V	±2.5 V	Bipolar		Unipolar [UINT*]	
Volt	Volt	Volt	Decimal	Hexadecimal	Decimal	Hexadecimal
-10	-5	-2.5	-32768	16#8000		
-9	-4.5	-2.25	-29492	16#8CCC		
-8	-4	-2	-26215	16#9999		
-7	-3.5	-1.75	-22938	16#A666		
-6	-3	-1.5	-19661	16#B333		
-5	-2.5	-1.25	-16384	16#C000		
-4	-2	-1	-13108	16#CCCC		
-3	-1.5	-0.75	-9831	16#D999		
-2	-1	-0.5	-6574	16#E666		
-1	-0.5	-0.25	-3292	16#F324		
0	0	0	0	0	0	0
1	0.5	0.25	3276	16#0CCC	6553	16#1999
2	1	0.5	6553	16#1999	13107	16#3332
3	1.5	0.75	9830	16#2666	19660	16#4CCC
4	2	1	13106	16#3332	26214	16#6665
5	2.5	1.25	16383	16#3FFF	32767	16#7FFF
6	3	1.5	19660	16#4CCC	39320	16#9998
7	3.5	1.75	22936	16#5998	45874	16#B332
8	4	2	26213	16#6665	52427	16#CCCB
9	4.5	2.25	29490	16#7332	58981	16#E665
10	5	2.5	32767	16#7FFF	65534	16#FFFE

*Data type conversion required

i NOTE

If the inputs are not used but switched on, the measured values displayed in the I / O image are floated. To prevent this, you should deactivate the measurement channel at the start parameters or set the input to ground (short-circuit when measuring differential signals).

Module options

Conversion of the analogue values can be synchronized with DC (Distributed Clocks) or SM (Sync Manager).

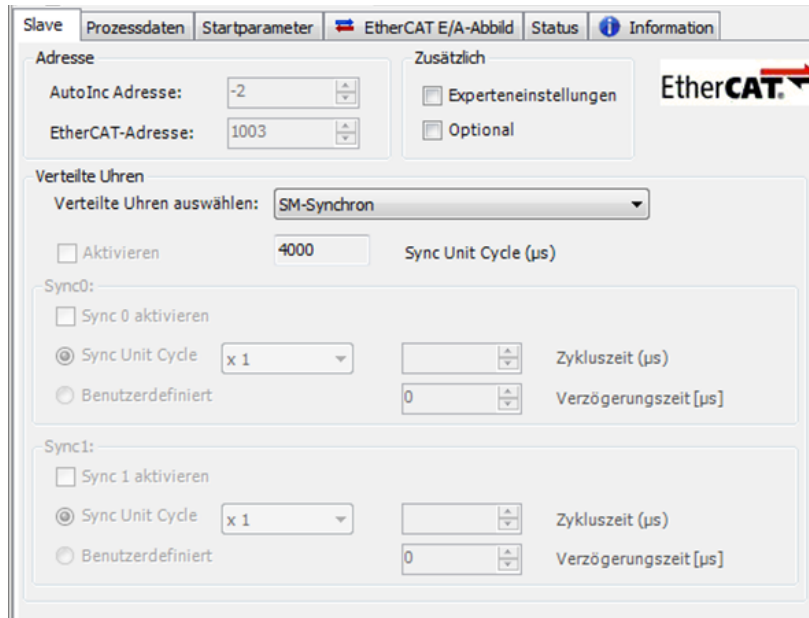

Figure 48: Module options

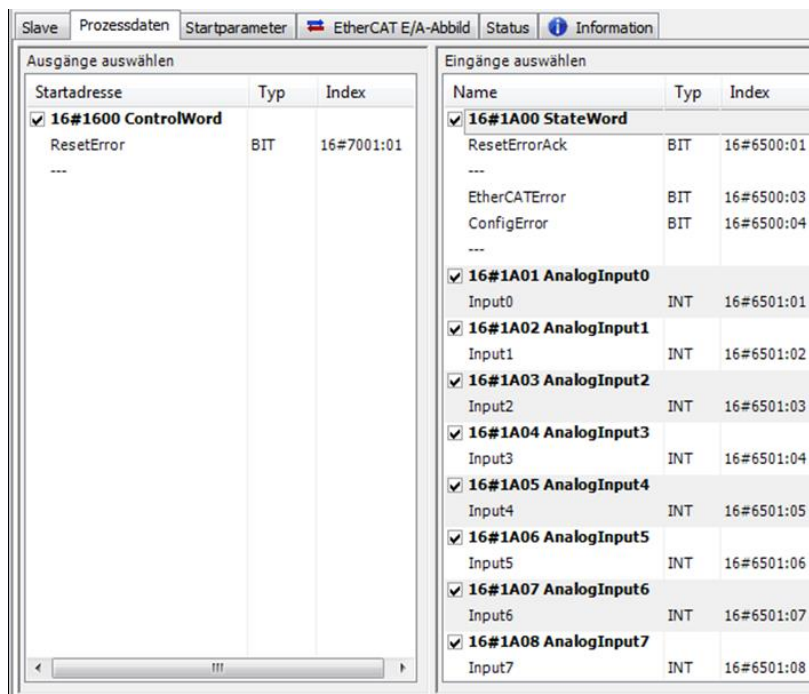

Figure 49: Process data

The process data objects stored as variables in the EtherCAT master's control program are used to access the input values and the module state.

Service data objects (SDO) are available for details and settings.

You may run the configuration tool offline and choose the "Startup Parameters" to change some settings of module AI8/16-U 13BIT CoE (such as the properties of each of the inputs). The EtherCAT master will apply the settings when starting up the module.

You can also use the SDO transfer components available for the EtherCAT master to change settings at runtime.

Click/tap on "Add...", choose an object, and set the appropriate value.

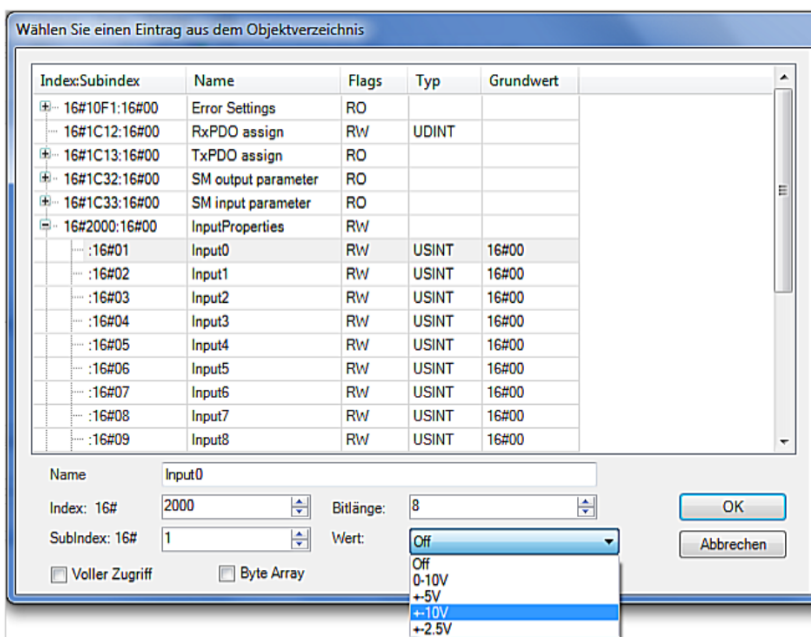

Figure 50: Object dictionary

You can set up the following options for every channel:

Module options		
Name	Value	Explanation
InputProperties	0	Off (default)
	1	0-10 V
	2	±5 V
	3	±10 V
	4	±2.5 V
InputSwitch	0	Single-Ended (default)
	1	Differential
Average	n=1...255	Inputn=average after n cycles (default=1)

StateWord

The state word is indicative of the module state:

StateWord		
Bit	Name	Explanation
0	ResetErrorAck	Acknowledges "Reset Error" in Module Control
1		not used
2	EtherCATErrror	Sync Manager Watchdog
3	ConfigError	Mismatch of Sync Manager's quantity structure
4-15		not used

Analogue inputs

Check the following variables for the digitized input values:

Inputs		
Variable	Data type	Explanation
Inputn	INT	Value of channel n (n= 0...15)

ControlWord

The control word contains a bit for acknowledging errors.

ControlWord		
Bit	Name	Explanation
0	ResetError	0 -> errors are retained, 1 -> errors cleared after removing their cause
1-15	-	not used

Object dictionary

Index	Name	Type	Default	Min Max	Access
1000	Device Type	UINT32	0x40191		RO
1001	Error Register	UINT8			RO
1008	Device Name	String	AI4/8-U 13-Bit		RO
1009	Hardware Version	String	1.00		RO
100A	Software Version	String	1.00		RO
1018	Identity Object	Array			
1018, 0	Number of Entries	UINT8	4		RO
1018, 1	Vendor Id	UINT32	0x0048554B		RO
1018, 2	Product Code	UINT32	185341		RO

Index	Name	Type	Default	Min Max	Access
1018, 3	Revision Number	UINT32	2		RO
1018, 4	Serial Number	UINT32	0		RO
2000	Analog Input Properties	Array			
2000, 0	Number of Entries	UINT8	16		RO
2000, 1	Input 0	UINT8	Off	Off (0), 0-10V (1), +5V (2) +-10V (3) +-2.5V (4)	RW
2000, 2	Input 1	UINT8	Off	Off (0), 0-10V (1), +5V (2) +-10V (3) +-2.5V (4)	RW
2000, 3	Input 2	UINT8	Off	Off (0), 0-10V (1), +5V (2) +-10V (3) +-2.5V (4)	RW
2000, 4	Input 3	UINT8	Off	Off (0), 0-10V (1), +5V (2) +-10V (3) +-2.5V (4)	RW
2000, 5	Input 4	UINT8	Off	Off (0), 0-10V (1), +5V (2) +-10V (3) +-2.5V (4)	RW
2000, 6	Input 5	UINT8	Off	Off (0), 0-10V (1), +5V (2) +-10V (3) +-2.5V (4)	RW
2000, 7	Input 6	UINT8	Off	Off (0), 0-10V (1), +5V (2) +-10V (3) +-2.5V (4)	RW
2000, 8	Input 7	UINT8	Off	Off (0), 0-10V (1), +5V (2) +-10V (3) +-2.5V (4)	RW
2000, 9	Input 8	UINT8	Off	Off (0), 0-10V (1), +5V (2) +-10V (3) +-2.5V (4)	RW

Index	Name	Type	Default	Min Max	Access
2000, 10	Input 9	UINT8	Off	Off (0), 0-10V (1), +-5V (2) +-10V (3) +-2.5V (4)	RW
2000, 11	Input 10	UINT8	Off	Off (0), 0-10V (1), +-5V (2) +-10V (3) +-2.5V (4)	RW
2000, 12	Input 11	UINT8	Off	Off (0), 0-10V (1), +-5V (2) +-10V (3) +-2.5V (4)	RW
2000, 13	Input 12	UINT8	Off	Off (0), 0-10V (1), +-5V (2) +-10V (3) +-2.5V (4)	RW
2000, 14	Input 13	UINT8	Off	Off (0), 0-10V (1), +-5V (2) +-10V (3) +-2.5V (4)	RW
2000, 15	Input 14	UINT8	Off	Off (0), 0-10V (1), +-5V (2) +-10V (3) +-2.5V (4)	RW
2000, 16	Input 15	UINT8	Off	Off (0), 0-10V (1), +-5V (2) +-10V (3) +-2.5V (4)	RW
2001	Number of Entries	UINT8	8		RO
2001, 1	Input 0_1 Switch	UINT8	Single-ended	Single-ended (0) Differential (1)	RW
2001, 2	Input 2_3 Switch	UINT8	Single-ended	Single-ended (0) Differential (1)	RW
2001, 3	Input 4_5 Switch	UINT8	Single-ended	Single-ended (0) Differential (1)	RW
2001, 4	Input 6_7 Switch	UINT8	Single-ended	Single-ended (0) Differential (1)	RW
2001, 5	Input 8_9 Switch	UINT8	Single-ended	Single-ended (0) Differential (1)	RW
2001, 6	Input 10_11 Switch	UINT8	Single-ended	Single-ended (0) Differential (1)	RW
2001, 7	Input 12_13 Switch	UINT8	Single-ended	Single-ended (0)	RW

Index	Name	Type	Default	Min Max	Access
				Differential (1)	
2001, 8	Input 14_15 Switch	UINT8	Single-ended	Single-ended (0) Differential (1)	RW
2003	Input Average	Array			
2003, 0	Number of Entries	UINT8	16		RO
2003, 1	Input 0 Average	UINT8	1	1..255	RW
2003, 2	Input 1 Average	UINT8	1	1..255	RW
2003, 3	Input 2 Average	UINT8	1	1..255	RW
2003, 4	Input 3 Average	UINT8	1	1..255	RW
2003, 5	Input 4 Average	UINT8	1	1..255	RW
2003, 6	Input 5 Average	UINT8	1	1..255	RW
2003, 7	Input 6 Average	UINT8	1	1..255	RW
2003, 8	Input 7 Average	UINT8	1	1..255	RW
2003, 9	Input 8 Average	UINT8	1	1..255	RW
2003, 10	Input 9 Average	UINT8	1	1..255	RW
2003, 11	Input 10 Average	UINT8	1	1..255	RW
2003, 12	Input 11 Average	UINT8	1	1..255	RW
2003, 13	Input 12 Average	UINT8	1	1..255	RW
2003, 14	Input 13 Average	UINT8	1	1..255	RW
2003, 15	Input 14 Average	UINT8	1	1..255	RW
2003, 16	Input 15 Average	UINT8	1	1..255	RW
6401	Analogue input	Array			
6401, 0	Number of Entries	UINT8	16		RO
6401, 1	Analog Input 0	UINT16			RO P
6401, 2	Analog Input 1	UINT16			RO P
6401, 3	Analog Input 2	UINT16			RO P
6401, 4	Analog Input 3	UINT16			RO P
6401, 5	Analog Input 4	UINT16			RO P
6401, 6	Analog Input 5	UINT16			RO P
6401, 7	Analog Input 6	UINT16			RO P
6401, 8	Analog Input 7	UINT16			RO P
6401, 9	Analog Input 8	UINT16			RO P
6401, 10	Analog Input 9	UINT16			RO P
6401, 11	Analog Input 10	UINT16			RO P
6401, 12	Analog Input 11	UINT16			RO P
6401, 13	Analog Input 12	UINT16			RO P
6401, 14	Analog Input 13	UINT16			RO P
6401, 15	Analog Input 14	UINT16			RO P
6401, 16	Analog Input 15	UINT16			RO P
6500	StateWord	Array			
6500, 0	Number of Entries	UINT8	16		RO
6500, 1	ResetErrorAck	BOOL			RO P
6500, 3	EtherCAT Error	BOOL			RO P
6500, 4	ConfigError	BOOL			RO P
7001	Module Control	Array			

Index	Name	Type	Default	Min Max	Access
7001, 0	Number of Entries	UINT8	1		RO
7001, 1	Reset Error	BOOL			RW P

RO=read-only, RW= read/write, P=process image

7.7.4. Technical data

AI8/16-U 13BIT CoE	
Label	MC-I/O AI8/16-U 13BIT CoE
Part no.	S-01030202-0400
Plug-in connector	36-pole S-02020201-0900 (not part of the module)
Analogue inputs	16 single ended or 8 differential
Resolution	13 bit
Measuring range	0 ... 10 V, ± 5 V, ± 10 V, ± 2.5 V
Start AD conversion	synchronized with DC / SM
Conversion time	580 μ s (if all channels are enabled)
Input filter cutoff frequency	typ. 1 kHz
Measuring error	$< \pm 0,4$ %, typ. $< \pm 0,2$ % of final value
Internal resistance	> 1 M Ω
Controller	ASIC ET1200
Baud rate	100 Mbit/s
E-bus port	10-pin system plug in side wall
Term. module	not required
Power supply	24 V DC -20 % +25 %
E-bus load	190 mA
UL approval	

7.8. Analogue outputs voltage / current AO4-U/I

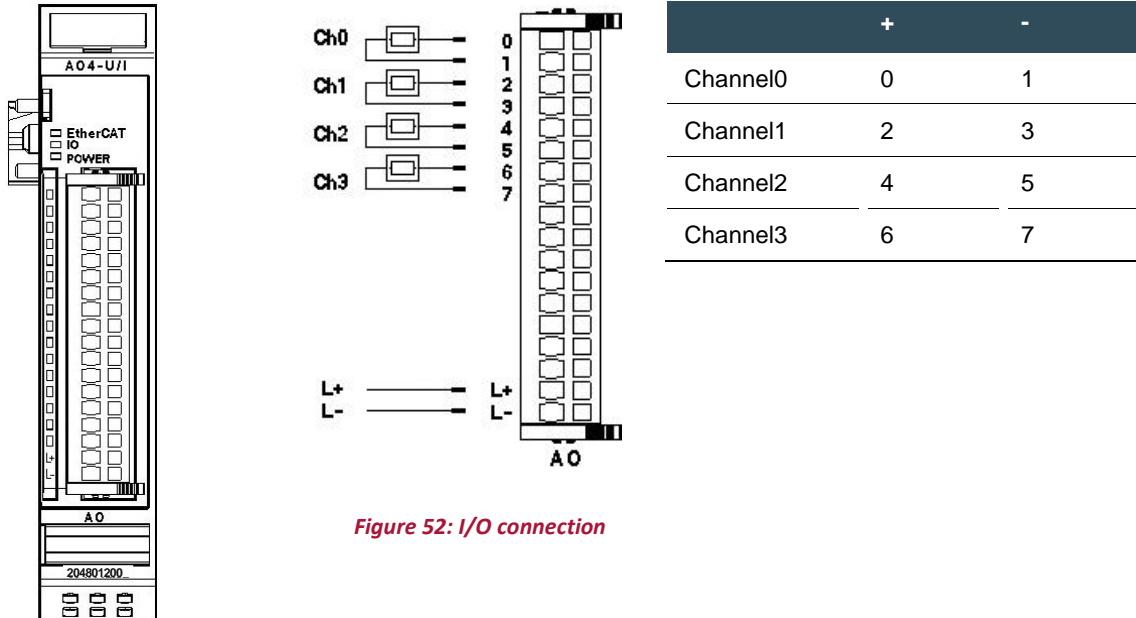

Figure 52: I/O connection

Figure 51: Front view of AO4-U/I I/O module

i NOTE

The AO4-U/I module is no longer recommended for new projects. Please use the successive AO4-U/I 16BIT CoE module.

7.8.1. Terminals

Power supply to module I/Os

L+: 24 V DC

L-: 0 V

7.8.2. Status LEDs

“EtherCAT” LED

The LED labeled “EtherCAT” indicates the state of the EtherCAT ASIC.

EtherCAT		
State	LED flash code	Explanation
Init	Red, on	Initializing, no data exchange
Pre-Op	Red/green, 1:1	Pre-operational, no data exchange
Safe-Op	Red/green, 5:1	Safe operation, inputs readable
Op	Green, on	Operational, unrestricted data exchange

“I/O” LED

The LED labeled “I/O” indicates the state of the module's I/Os.

I/O		
State	LED flash code	Explanation
Ok	Green, on	No error
Error	Off	Malfunction of module if E-bus LED = On
		Inoperative if E-bus LED = Off
	Red, 1x	Short circuit
	Red, 2x	Low voltage
	Red, 4x	EtherCAT watchdog control
	Red, 6x	Module-specific fault
	Red, 7x	Configuration error (E-bus pre-operational), no. of process data differs from that in the module
Defective	Red, on	Module defective

“Power” LED

The LED labeled "Power" indicates the state of the I/O module's I/O power supply.

Power		
State	LED flash code	Explanation
On	Green, on	24 V DC supply ok
Off	Off	24 V DC supply not ok

“Channel” LEDs

Channel		
State	LED flash code	Explanation
On	Green, on	Channel enabled
Off	Off	Channel disabled
Error	Red, 1x	Short circuit
	Red, 3x	Broken wire
	Red, 5x	Excessive temp. of output drivers

7.8.3. Function

The AO4-U/I module has 4 analogue outputs. Every channel can be separately set to the unipolar or bipolar output of voltages or currents.

The letter 'n' in the tables below represents the channel number (n=0...3).

Analogue outputs

Write the output values into the following variables:

Outputs		
Variable	Data type	Explanation
Channel_n	INT	Output value for channel n (n=0...3)

Values voltage

see table page 84

Values current

0 ... 0xFFFF0 for 0... 20 mA

Module control

The module provides you with various operational options.

To set up the module choose the options as appropriate and accept by setting control bit "SetOptions" to a rising edge. The module will confirm by returning "OptionsSet".

There are various "module error" bits that the module uses to indicate errors. The states of the error bits are retained and also used for error indication by the "I/O" LED.

To reset the error bits set control bit "ResetError" to a rising edge.

Error bits		
Variable	Data type	Explanation
SetOptions	BOOL	Rising edge <input type="checkbox"/> accepts module options
ResetError	BOOL	Rising edge <input type="checkbox"/> acknowledges error

Module options

The following options are available for module AO4:

Module options		
Variable	Data type	Explanation
Channel_n_On	BOOL	Enables channel n (set to high impedance to disable)
Channel_n_Current	BOOL	Sets channel n to current output mode
Channel_n_n+1_Unipolar	BOOL	Sets channels 1 and 2 or 2 and 3 to unipolar mode
Outputs_Active_Shortcut	BOOL	Leave outputs unchanged after short circuit
Outputs_Active_Undervoltage	BOOL	Leave outputs unchanged after low voltage
Outputs_Active_Specific_Error	BOOL	Leave outputs unchanged after module-specific error
Outputs_Active_EtherCAT_Error	BOOL	Leave outputs unchanged after short circuit
n		0 ... 3 Channel number

To set and accept options, see section Module control

Module state

The following states are indicated:

Module state		
Variable	Data type	Explanation
Shortcut	BOOL	Short circuit (not used)
Undervoltage	BOOL	Low voltage (supplied power < 19.2 V)
Watchdog	BOOL	Internal watchdog of module
EtherCAT_Error	BOOL	Configuration error or watchdog control
Specific_Error	BOOL	Module-specific fault
OptionsSet	BOOL	Sent by module to acknowledge SetOptions

To reset the messages, see section Module control

Module-specific messages

Apart from the module error messages, there is a set of messages containing details about the current state of the module:

Messages		
Variable	Data type	Explanation
Channel_n_Overtemp	BOOL	Temperature of output driver of channel n > 140 °C (automatic switch-off) <input type="checkbox"/> Outputs_Active_Shortcut = TRUE
Undervoltage_24	BOOL	Power supplied to module > 19.2V <input type="checkbox"/> Outputs_Active_Undervoltage = TRUE
Channel_n_Open	BOOL	Current mode: channel n load is > 500 <input type="checkbox"/> <input type="checkbox"/> Specific_Error = TRUE
Channel_n_Shortcut	BOOL	Voltage mode: channel n load is < 600 <input type="checkbox"/> <input type="checkbox"/> Specific_Error = TRUE

These messages are automatically reset when the state concerned has returned to normal.

These messages are summarized as "Specific_Error" in the module status and mapped as "Module-specific error" onto the I/O-LED.

Conversion time

The AO4-U/I module operates with a cycle time of 320µs which is independent of the number of the enabled channels (time from the acquisition of the output values to the start of the D/A converters).

7.8.4. Technical data

AO4-U/I	
Label	MC-I/O AO4-U/I 12BIT
Part no.	204801200
Plug-in connector	18-pole S-02020201-0800 (not part of the module)
Analogue outputs	4
Resolution	16 bit, 12 bit
Measuring range	0 ... 10 V, ± 10 V, 0 ... +20 mA
Output frequency	3.125 kHz
Controller	ASIC ET1200
Baud rate	100 Mbit/s
E-bus port	10-pin system plug in side wall
Term. module	not required
Power supply	24 V DC -20% +25%
E-bus load	150 mA
UL approval	

i NOTE

Measuring range 0 ... +20 mA

In order to use the current outputs, the "Channel_n_n + 1_Unipolar" variable of the corresponding outputs must be set to TRUE.

See section Module options, short circuit undetectable.

7.9. Analogue outputs voltage / current AO4-U/I 16BIT CoE

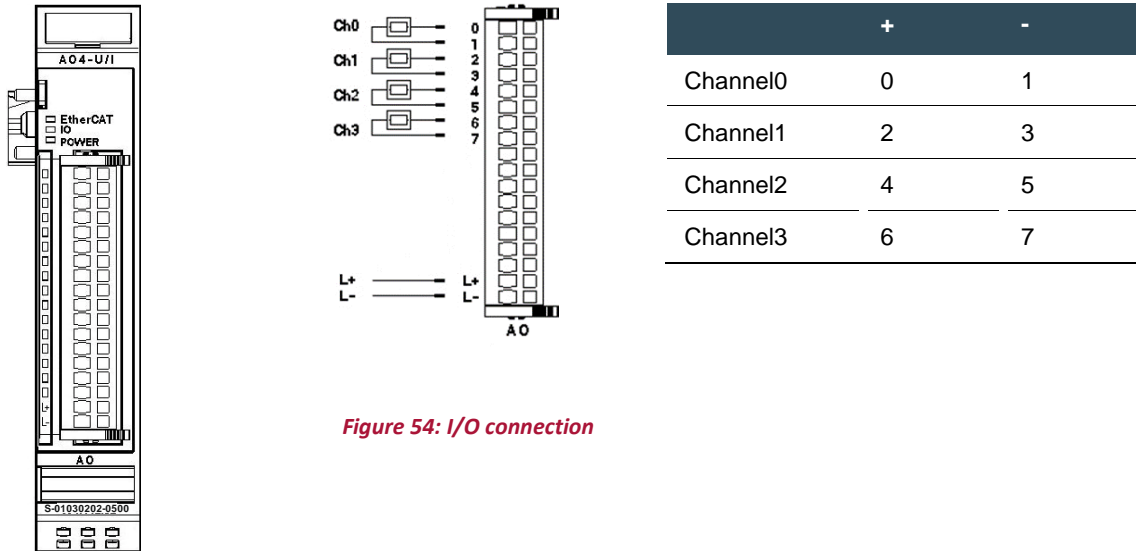

Figure 54: I/O connection

Figure 53: Front view of AO4-U/I

i NOTE

The AO4-U/I 16BIT CoE module is the successor module NOT compatible with the AO4-U/I 12BIT module.

Before replacing an AO4-U/I 12BIT module with an AO4-U/I 16BIT CoE module, you must modify the EtherCAT master's control program.

7.9.1. Terminals

Power supply to module I/Os

L+: 24 V DC

L-: 0 V

7.9.2. Status LEDs

“EtherCAT” LED

The LED labeled “EtherCAT” indicates the state of the EtherCAT ASIC.

EtherCAT		
State	LED flash code	Explanation
Init	Red, on	Initializing, no data exchange
Pre-Op	Red/green, 1:1	Pre-operational, no data exchange
Safe-Op	Red/green, 5:1	Safe operation, inputs readable
Op	Green, on	Operational, unrestricted data exchange

“I/O” LED

The LED labeled “I/O” indicates the state of the module's I/Os.

I/O		
State	LED flash code	Explanation
Ok	Green, on	No error
Error	Off	Malfunction of module if E-bus LED = On Inoperative if E-bus LED = Off
	Red, 1x	Short circuit
	Red, 2x	Low voltage
	Red, 4x	EtherCAT watchdog control
	Red, 6x	Module-specific fault
	Red, 7x	Configuration error (E-bus pre-operational), no. of process data differs from that in the module
	Defective	Red, on

“Power” LED

The LED labeled "Power" indicates the state of the I/O module's I/O power supply.

Power		
State	LED flash code	Explanation
On	Green, on	24 V DC supply ok
Off	Off	24 V DC supply not ok

“Channel” LEDs

The "Channel" LEDs indicate the state of every channel.

Channel		
State	LED flash code	Explanation
On	Green, on	Channel enabled
Off	Off	Channel disabled
Error	Red, 1x	Short circuit
	Red, 3x	Broken wire
	Red, 5x	Excessive temp. of output drivers

7.9.3. Function

The AO4-U/I 16BIT CoE module has 4 analogue outputs. Every channel can be separately set to the unipolar or bipolar output of voltages or currents.

To output voltage or current readings (measured values) to the analogue outputs, verify that the associated output variables contain these values in the 2-byte two's complement format.

The letter 'n' in the tables below represents the channel number (n=0...3).

Analogue voltage/current values

Measured value				Variable value (@ 16 bits)			
±10/10	0...20	4...20	0...24	Bipolar [UINT]		Unipolar [UINT]	
Volt	mA	mA	mA	Decimal	Hexadecimal	Decimal	Hexadecimal
-10				32768	16#8000		
-9				36044	16#8CCC		
-8				39321	16#9999		
-7				42598	16#A666		
-6				45875	16#B333		
-5				49152	16#C000		
-4				52428	16#CCCC		
-3				55705	16#D999		
-2				58982	16#E666		
-1				62244	16#F324		
0	0	4	0	0	0	0	0
1	2	5.6	2.4	3276	16#0CCC	6553	16#1999
2	4	7.2	4.8	6553	16#1999	13107	16#3332
3	6	8.8	7.2	9830	16#2666	19660	16#4CCC
4	8	10.4	9.6	13106	16#3332	26214	16#6665
5	10	12.0	12.0	16383	16#3FFF	32767	16#7FFF
6	12	13.6	14.4	19660	16#4CCC	39320	16#9998
7	14	15.2	16.8	22936	16#5998	45874	16#B332
8	16	16.8	19.2	26213	16#6665	52427	16#CCCB
9	18	18.4	21.6	29490	16#7332	58981	16#E665
10	20	20.0	24.0	32767	16#7FFF	65534	16#FFFE

Please note the following differences:

MC-I/O AO4-U/I 12BIT	MC-I/O AO4-U/I 16BIT CoE
Current: 0...±20 mA	Current: 0...+20 mA
Short-circuit detectable	Short-circuit not detectable but outputs are short circuit-protected
Output not synchronized with EtherCAT	Output synchronized with SM or DC

Module options

Output of the analogue values can be synchronized with DC (Distributed Clocks) or SM (Sync Manager).

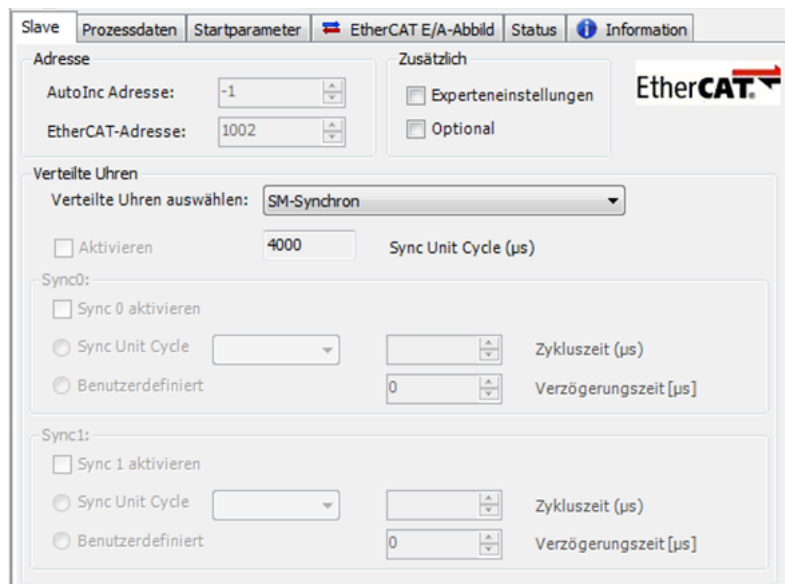

Figure 55: Module options

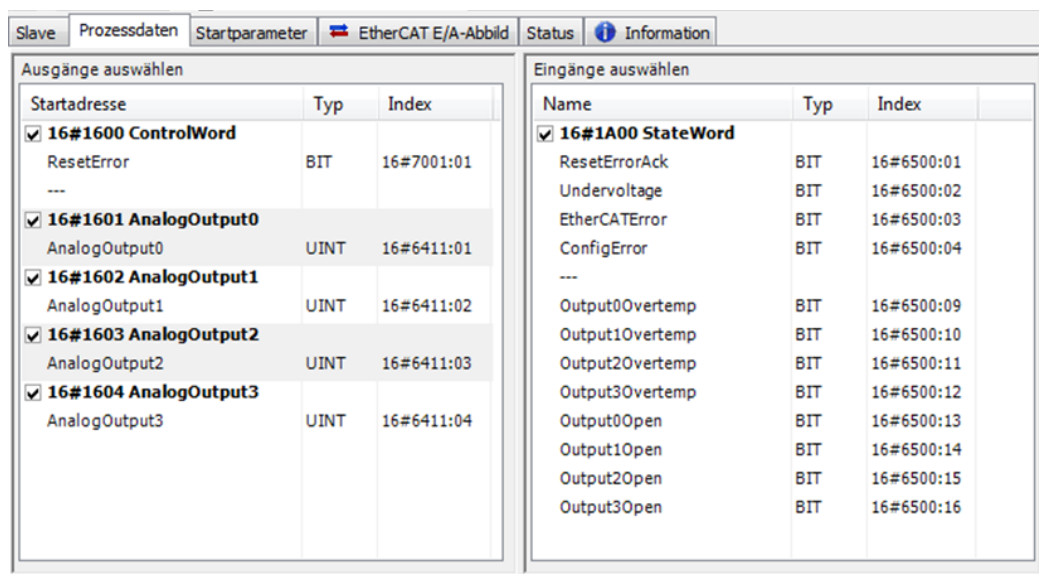

Figure 56: Process data

The process data objects stored as variables in the EtherCAT master's control program are used to access the output values and the module state.

Service data objects (SDO) are available for details and settings.

You may run the configuration tool offline to change some settings of module AO4-U/I 16BIT CoE (such as the properties of each of the outputs). The EtherCAT master will apply the settings when starting up the module.

You can also use the SDO transfer components available for the EtherCAT master to change settings at runtime.

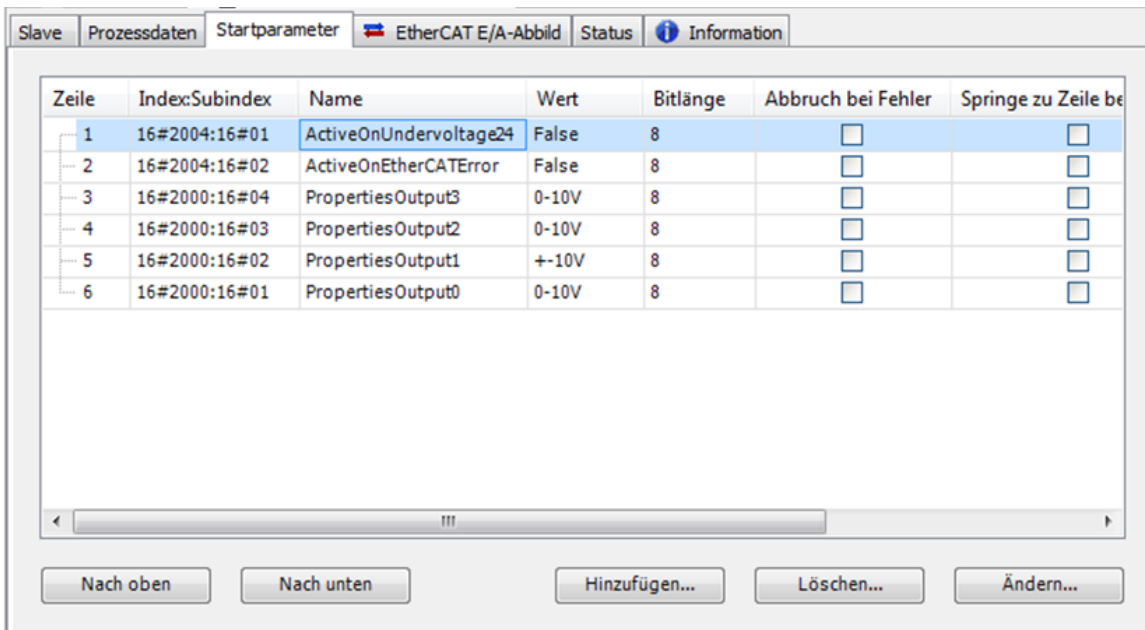

Figure 57: Start parameter

Click/tap on "Add...", choose an object, and set the appropriate value.

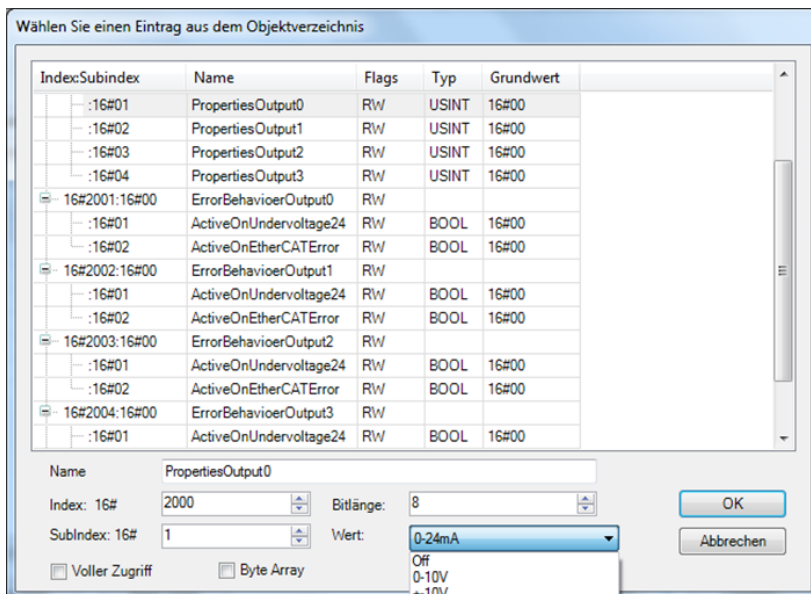

Figure 58: Click/tap on "Add"

StateWord

The state word is indicative of the module state:

StateWord		
Bit	Name	Bedeutung
0	ResetErrorAck	Acknowledges "Reset Error" in Module Control
1	Undervoltage24	24 V supply low
2	EtherCATErrror	Sync Manager Watchdog
3	ConfigError	Mismatch of Sync Manager's quantity structure
4	-	
5	-	
6	-	
7	-	
8	Output 0 Overtemp	Over-temperature detected by output driver (automatic switch-off)
9	Output 1 Overtemp	Over-temperature detected by output driver (automatic switch-off)
10	Output 2 Overtemp	Over-temperature detected by output driver (automatic switch-off)
11	Output 3 Overtemp	Over-temperature detected by output driver (automatic switch-off)
12	Output 0 Open	If there is no current in Current mode
13	Output 1 Open	If there is no current in Current mode
14	Output 2 Open	If there is no current in Current mode
15	Output 3 Open	If there is no current in Current mode

Analogue outputs

Write the output values into the following variables:

Outputs		
Variable	Data type	Explanation
AnalogOutputn	UINT	Output value of channel n (n=0...3)

ControlWord

The control word contains a bit for acknowledging errors.

ControlWord		
Bit	Name	Explanation
0	ResetError	0 -> errors are retained, 1 -> errors cleared after removing their cause
1-15	-	not used

Object dictionary

Index	Name	Type	Default	Min Max	Access
1000	Device Type	UINT32	0xF0191		RO
1001	Error Register	UINT8			RO
1008	Device Name	String			RO
1009	Hardware Version	String	1.00		RO
100A	Software Version	String	1.00		RO
1018	Identity Object	ARRAY			
1018, 0	Number of Entries	UINT8	4		RO
1018, 1	Vendor Id	UINT32	0x0048554B		RO
1018, 2	Product Code	UINT32			RO
1018, 3	Revision Number	UINT32	2		RO
1018, 4	Serial Number	UINT32	0		RO
2000	Analogue Output Properties	Array			
2000, 0	Number of Entries	UINT8	4		RO
2000, 1	Properties Output 0	UINT8	0-10V	Off (0), 0-10V (1), +-10V (3), 0-20mA (6), 4-20mA (5), 0-24mA (7)	RW
2000, 2	Properties Output 1	UINT8	0-10V	Off, 0-10V, +-10V, 0-20mA, 4-20mA, 0-24mA	RW
2000, 3	Properties Output 2	UINT8	0-10V	Off, 0-10V, +-10V, 0-20mA, 4-20mA, 0-24mA	RW
2000, 4	Properties Output 3	UINT8	0-10V	Off, 0-10V, +-10V, 0-20mA, 4-20mA, 0-24mA	RW
2001	ErrorBehavior Output 0	Array			
2001, 0	Number of Entries	UINT8	2		RO
2001, 1	Active on Undervoltage 24	BOOL	FALSE		RW
2001, 1	Active on EtherCAT Watchdog Error	BOOL	FALSE		RW
2002	ErrorBehavior Output 1	Array			
2002, 0	Number of Entries	UINT8	2		RO
2002, 1	Active on Undervoltage 24	BOOL	FALSE		RW

Index	Name	Type	Default	Min Max	Access
2002, 1	Active on EtherCAT Watchdog Error	BOOL	FALSE		RW
2003	ErrorBehavior Output 2	Array			
2003, 0	Number of Entries	UINT8	2		RO
2003, 1	Active on Undervoltage 24	BOOL	FALSE		RW
2003, 1	Active on EtherCAT Watchdog Error	BOOL	FALSE		RW
2004	ErrorBehavior Output 3	Array			
2004, 0	Number of Entries	UINT8	2		RO
2004, 1	Active on Undervoltage 24	BOOL	FALSE		RW
2004, 1	Active on EtherCAT Watchdog Error	BOOL	FALSE		RW
6411	Analogue Outputs	Array			
6411, 0	Number of Entries	UINT8	4		RO
6411, 1	Analogue Output 0	UINT16			RW P
6411, 2	Analogue Output 1	UINT16			RW P
6411, 3	Analogue Output 2	UINT16			RW P
6411, 4	Analogue Output 3	UINT16			RW P
6500	State Word	Array			
6500, 0	Number of Entries	UINT8	16		RO
6500, 1	Reset Error Ack	BOOL			RO P
6500, 2	Undervoltage24	BOOL			RO P
6500, 3	EtherCAT Error	BOOL			RO P
6500, 4	ConfigError	BOOL			RO P
6500, 5	-	BOOL			RO P
6500, 6	-	BOOL			RO P
6500, 7	-	BOOL			RO P
6500, 8	-	BOOL			RO P
6500, 9	Output 0 Overtemp	BOOL			RO P
6500, 10	Output 1 Overtemp	BOOL			RO P
6500, 11	Output 2 Overtemp	BOOL			RO P
6500, 12	Output 3 Overtemp	BOOL			RO P
6500, 13	Output 0 Open	BOOL			RO P
6500, 14	Output 1 Open	BOOL			RO P
6500, 15	Output 2 Open	BOOL			RO P
6500, 16	Output 3 Open	BOOL			RO P
7001	Control Word	Array			
7001, 0	Number of Entries	UINT8	1		RO
7001, 1	Reset Error	BOOL			RW P

RO=read-only, RW= read/write, P=process image

7.9.4. Technical data

AO4-U/I 16BIT CoE	
Label	MC-I/O AO4-U/I 16BIT CoE
Part no.	S-01030202-0500
Plug-in connector	18-pole S-02020201-0800 (not part of the module)
Analogue outputs	4
Resolution	16 Bit
Output frequency	Synchronized with SM / DC
Intrinsic error	±0,2 %
Temperature error	±0,005 %/K
Destruction limit (external voltages)	15 V
Voltage	
Measuring range	0 ... 10 V, ±10 V
Short circuit protection	Yes
Short circuit current	max. 30 mA
Load resistance	min. 1 kΩ
Settling time	0 → 10 V: ≤ 22 μs at 2 kΩ/<200 pF
Current	
Measuring range	0...20 mA, 4...20 mA, 0...24 mA
Load resistance	max. 500 Ω, max. 1 mH (inductive)
Settling time	0 → 16 V: ≤ 25 μs at 300 Ω/<1 mH
Controller	ASIC ET1200
Baud rate	100 Mbit/s
E-bus port	10-pin system plug in side wall
Term. module	not required
Power supply	24 V DC -20 % +25 %
E-bus load	150 mA
UL approval	 <p> UL LISTED 59DM E242595 IND.CONT.EQ. </p>

8. Temperature modules

8.1. Analogue temperature inputs AI4-PT/Ni100, AI4-PT/Ni1000

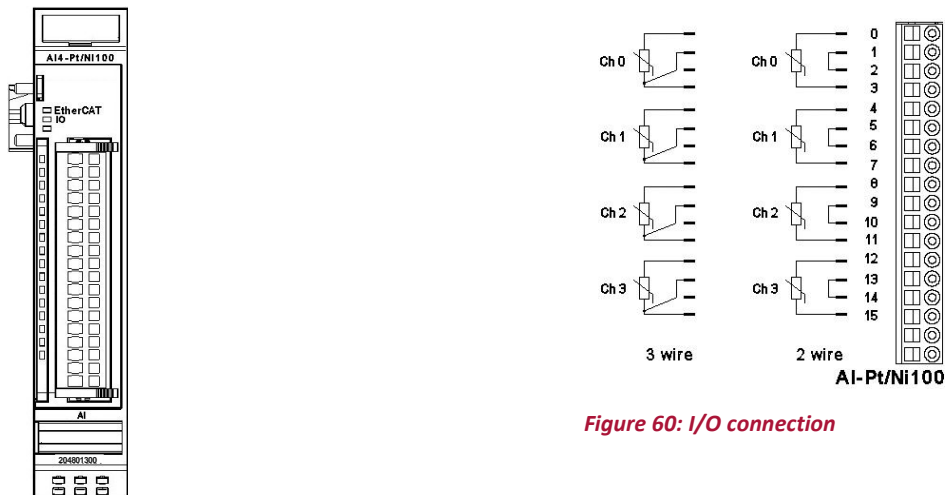

Figure 59: Front view of AI4-PT/Ni100 I/O module

Figure 60: I/O connection

i NOTE

The AI4-PT/Ni100 module and the AI4-PT/Ni1000 module are no longer recommended for new projects. Please use the successive AI4-PT/NI/THERMO 16BIT CoE module.

8.1.1. Terminals

The module needs no separate 24 V connector. Power is supplied to the module through the E-bus connector.

Operative earth / shielding of analog wires □ section 3.1.1 Earth

8.1.2. Status LEDs

“EtherCAT” LED

The LED labeled “EtherCAT” indicates the state of the EtherCAT ASIC.

EtherCAT		
State	LED flash code	Explanation
Init	Red, on	Initializing, no data exchange
Pre-Op	Red/green, 1:1	Pre-operational, no data exchange
Safe-Op	Red/green, 5:1	Safe operation, inputs readable
Op	Green, on	Operational, unrestricted data exchange

“I/O” LED

The LED labeled “I/O” indicates the state of the module’s I/Os.

I/O		
State	LED flash code	Explanation
Ok	Green, on	No error
Error	Off	Malfunction of module if E-bus LED = On
		Inoperative if E-bus LED = Off
	Red, 4x	EtherCAT watchdog control
	Red, 6x	Module-specific fault
	Red, 7x	Configuration error (E-bus pre-operational), no. of process data differs from that in the module
Defective	Red, on	Module defective

“Power” LED

There is no LED labeled “Power” because a separate power feed is not required.

“Channel” LEDs

Channel		
State	LED flash code	Explanation
On	Green, on	Channel enabled
Off	Off	Channel disabled
Error	Red	Short circuit, broken wire

8.1.3. Function

Module AI4-PT/NI100 has 4 analogue inputs for PT100 or NI100 temperature sensors. It can also measure resistances between 70 and 330 Ω .

Module AI4-PT/NI1000 has 4 analogue inputs for PT1000 or NI1000 temperature sensors. It can also measure resistances between 700 and 3000 Ω .

The letter 'n' in the tables below represents the channel number (n=0...3).

Analogue inputs

Check the following variable for the digitized input values:

Inputs				
Variable	Data type	Explanation		
Channel_n	INT	Value measured on channel n (n= 0...3)		
		Default	in 1/10 °C	
		ResMode	PT100	in 1/100 Ω
			PT1000	in 1/10 Ω

Module control

The module provides you with various operational options.

To set up the module choose the options as appropriate and accept by setting control bit "SetOptions" to a rising edge. The module will confirm by returning "OptionsSet".

There are various "module error" bits that the module uses to indicate errors. The states of the error bits are retained and also used for error indication by the "I/O" LED.

To reset the error bits set control bit "ResetError" to a rising edge.

Error bits		
Variable	Data type	Explanation
SetOptions	BOOL	Rising edge <input type="checkbox"/> accepts module options
ResetError	BOOL	Rising edge <input type="checkbox"/> acknowledges error

Module options

The following options are available for module AI4-PT/NI100 or 1000:

Module options			
Variable	Data type	Explanation	
Channel_n_Ni	BOOL	Set channel n to NI100 sensor	
Channel_n_On	BOOL	Enables channel n	
Channel_n_ResMode	BOOL	Set channel n to resistance mode	
Channel_n_Filter	USINT	Set filter for channel n The arithmetic mean is output after n+1 conversions.	
n		0 ... 3	Channel number

To set and accept options, see Module control

Module state

The following module states are indicated:

Module state		
Variable	Data type	Explanation
Shortcut	BOOL	Not used
Undervoltage	BOOL	Not used
Watchdog	BOOL	Internal watchdog of module
EtherCAT_Error	BOOL	Configuration error or watchdog control
Specific_Error	BOOL	Module-specific fault
OptionsSet	BOOL	Sent by module to acknowledge SetOptions

To reset the messages, see Module control

Module-specific messages

Apart from the module error messages, there is a set of messages containing details about the current state of the module:

Messages		
Variable	Data type	Explanation
Channel_n_Open	BOOL	<ul style="list-style-type: none"> - Channel n load > maximum - Broken wire of connector 0 * - Broken wire of connector 3 * - Broken wire of connector 0/3 * → Specific_Error = TRUE
Channel_n_Shortcut	BOOL	<ul style="list-style-type: none"> - Channel n load < minimum - Short circuit of connector 0-3 * - Broken wire of connector 1 * → Specific_Error = TRUE

* The causes of 'Short circuit' and 'Broken wire 0..3' are shown for channel 0 (equivalent applies to other channels).

These messages are automatically reset when the state concerned has returned to normal.

They are combined into a single "Specific_Error" state of the module and output to the I/O LED as "module-specific error".

Conversion time

The analogue signals are converted one by one down every channel. Disabling one or several channels will shorten the entire A/D conversion cycle.

'Filter' in this case means to compute an average when the set filter time is over.

Analogue value conversion runs cyclically and is not synchronized with the receipt of EtherCAT telegrams.

The cycle consists of the analogue value conversion plus transmitting the values into the EtherCAT data area.

Channel	
Number of channels	Cycle time in ms (all filters=0)
1	32
2	65
3	97
4	129

i NOTE

If you are aiming for a high sampling frequency, the EtherCAT master should do the filtering (averaging) because it will normally have much more processing power.

i NOTE

Take the EtherCAT cycle into account to assess how much the values stored by the EtherCAT master are up-to-date. The module described in this section will accept the above times as the ideal EtherCAT cycle setup.

Quality of analogue values

i NOTE

Best results are obtained by connecting the shield of the signal cables to operative earth.

8.1.4. Technical data AI4-PT/NI100

AI4-PT/NI100	
Label	MC-I/O AI4-PT/NI100 16BIT
Part no.	204801300
Plug-in connector	18-pole S-02020201-0800 (not part of the module)
Analogue inputs	4
Resolution	16 bit (resistance 0.01 Ω , temperature 0.1°C)
Pt100 measuring range	- 75°C...+ 670°C
Ni100 measuring range	- 60°C...+ 250°C
Resistance	70...330 Ω
Temperature drift	< \pm 50 ppm/°C regarding range limit
Critical frequency	typical 2 Hz
Measurement current	< 0.50 mA
Sampling frequency	> 7.75 Hz (if all channels are enabled)
Controller	ASIC ET1200
Baud rate	100 Mbit/s
E-bus port	10-pin system plug in side wall
Term. module	not required
Power supply	24 V DC -20% +25%
E-bus load	150 mA
UL approval	

8.1.5. Technical data AI4-PT/Ni1000

AI4-PT/Ni1000	
Label	MC-I/O AI4-PT/Ni1000 16BIT
Part no.	204802800
Plug-in connector	18-pole S-02020201-0800 (not part of the module)
Analogue inputs	4
Resolution	16 bit (resistance 0.1 Ω , temperature 0.1°C)
Pt100 measuring range	- 75°C...+ 570°C
Ni100 measuring range	- 60°C...+ 250°C
Resistance	700...3000 Ω
Temperature drift	< \pm 60 ppm/°C regarding range limit
Critical frequency	typical 2 Hz
Measurement current	< 0.12 mA
Sampling frequency	> 7.75 Hz (if all channels are enabled)
Controller	ASIC ET1200
Baud rate	100 Mbit/s
E-bus port	10-pin system plug in side wall
Term. module	not required
Power supply	24 V DC -20% +25%
E-bus load	150 mA
UL approval	 <p> UL LISTED <small>59DM</small> <small>E242595</small> <small>IND.CONT.EQ.</small> </p>

8.2. Analogue temperature inputs AI8-PT/Ni100

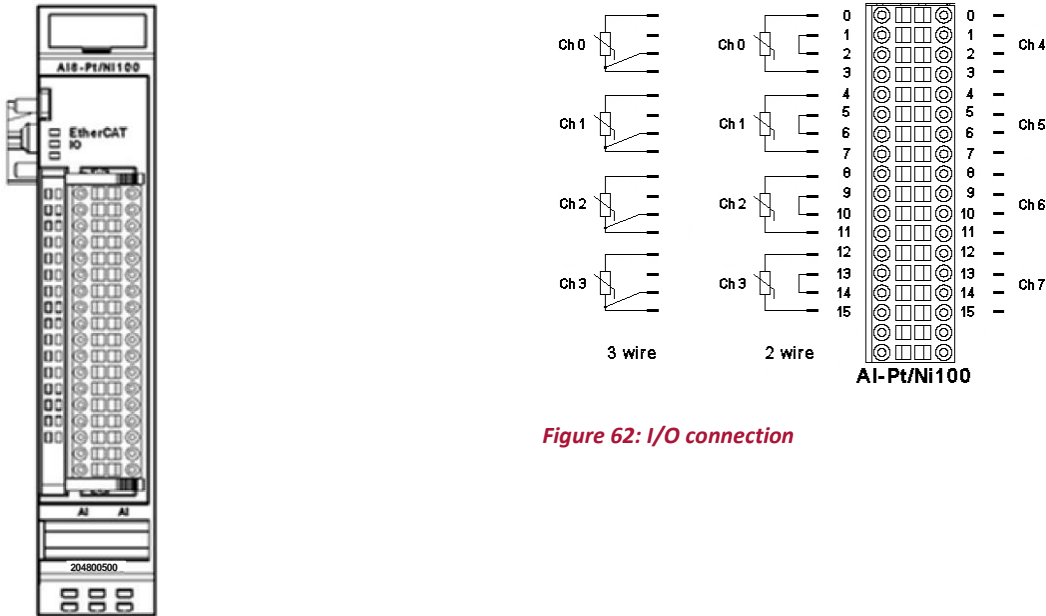

Figure 62: I/O connection

Figure 61: Front view of AI8-PT/Ni100 I/O module

i NOTE

The AI8-PT/Ni100 module is no longer recommended for new projects. Please use the successive AI8-PT/Ni/THERMO 16BIT CoE module.

8.2.1. Terminals

The module needs no separate 24 V connector. Power is supplied to the module through the E-bus connector.

Operative earth / shielding of analog wires □ section 3.1.1 Earth

8.2.2. Status LEDs

“EtherCAT” LED

The LED labeled “EtherCAT” indicates the state of the EtherCAT ASIC.

EtherCAT		
State	LED flash code	Explanation
Init	Red, on	Initializing, no data exchange
Pre-Op	Red/green, 1:1	Pre-operational, no data exchange
Safe-Op	Red/green, 5:1	Safe operation, inputs readable
Op	Green, on	Operational, unrestricted data exchange

“I/O” LED

The LED labeled “I/O” indicates the state of the module's I/Os.

I/O		
State	LED flash code	Explanation
Ok	Green, on	No error
Error	Off	Malfunction of module if E-bus LED = On
		Inoperative if E-bus LED = Off
	Red, 4x	EtherCAT watchdog control
	Red, 6x	Module-specific fault
	Red, 7x	Configuration error (E-bus pre-operational), no. of process data differs from that in the module
Defective	Red, on	Module defective

“Power” LED

There is no LED labeled “Power” because a separate power feed is not required.

“Channel” LEDs

Channel		
State	LED flash code	Explanation
On	Green, on	Channel enabled
Off	Off	Channel disabled
Error	Red	Short circuit, broken wire

8.2.3. Function

Module AI8-PT/NI100 has 8 analogue inputs for PT100 or NI100 temperature sensors. It can also measure resistances between 70 and 330 Ω .

The letter 'n' in the tables below represents the channel number (n=0...7).

Analogue inputs

Check the following variable for the digitized input values:

Inputs			
Variable	Data type	Explanation	
Channel_n	INT	Value measured on channel n (n= 0...7)	
		Default	in 1/10 °C
		ResMode	PT100 in 1/100 Ω

Module control

The module provides you with various operational options.

To set up the module choose the options as appropriate and accept by setting control bit “SetOptions” to a rising edge. The module will confirm by returning “OptionsSet”.

There are various “module error” bits that the module uses to indicate errors. The states of the error bits are retained and also used for error indication by the “I/O” LED.

To reset the error bits set control bit “ResetError” to a rising edge.

Error bits		
Variable	Data type	Explanation
SetOptions	BOOL	Rising edge <input type="checkbox"/> accepts module options
ResetError	BOOL	Rising edge <input type="checkbox"/> acknowledges error

Module options

The following options are available for module AI8-PT/NI100:

Module options			
Variable	Data type	Explanation	
Channel_n_Ni	BOOL	Set channel n to NI100 sensor	
Channel_n_On	BOOL	Enables channel n	
Channel_n_ResMode	BOOL	Set channel n to resistance mode	
Channel_n_Filter	USINT	Set filter for channel n The arithmetic mean is output after n+1 conversions.	
n		0 ... 7	Channel number

To set and accept options, see Module control

Module state

The following module states are indicated:

Module state		
Variable	Data type	Explanation
Shortcut	BOOL	Not used
Undervoltage	BOOL	Not used
Watchdog	BOOL	Internal watchdog of module
EtherCAT_Error	BOOL	Configuration error or watchdog control
Specific_Error	BOOL	Module-specific fault
OptionsSet	BOOL	Sent by module to acknowledge SetOptions

To reset the messages, see Module control

Module-specific messages

Apart from the module error messages, there is a set of messages containing details about the current state of the module:

Messages		
Variable	Data type	Explanation
Channel_n_Open	BOOL	- Channel n load > maximum - Broken wire of connector 0 * - Broken wire of connector 3 * - Broken wire of connector 0/3 * → Specific_Error = TRUE
Channel_n_Shortcut	BOOL	- Channel n load < minimum - Short circuit of connector 0-3 * - Broken wire of connector 1 * → Specific_Error = TRUE

* The causes of 'Short circuit' and 'Broken wire 0..3' are shown for channel 0 (equivalent applies to other channels).

These messages are automatically reset when the state concerned has returned to normal. They are combined into a single "Specific_Error" state of the module and output to the I/O LED as "module-specific error".

Conversion time

The analogue signals are converted one by one down every channel. Disabling one or several channels will shorten the entire A/D conversion cycle.

'Filter' in this case means to compute an average when the set filter time is over. Analogue value conversion runs cyclically and is not synchronized with the receipt of EtherCAT telegrams. The cycle consists of the analogue value conversion plus transmitting the values into the EtherCAT data area.

Channel			
Number of channels	Cycle time in ms (all filters=0)	Number of channels	Cycle time in ms (all filters=0)
1	34	5	162
2	66	6	194
3	98	7	226
4	130	8	258

i NOTE

If you are aiming for a high sampling frequency, the EtherCAT master should do the filtering (averaging) because it will normally have much more processing power.

i NOTE

Take the EtherCAT cycle into account to assess how much the values stored by the EtherCAT master are up-to-date. The module described in this section will accept the above times as the ideal EtherCAT cycle setup.

Quality of analogue values

i NOTE

Best results are obtained by connecting the shield of the signal cables to operative earth.

8.2.4. Technical data AI8-PT/Ni100

AI8-PT/Ni100	
Label	MC-I/O AI8-PT/Ni100 16BIT
Part no.	204800500
Plug-in connector	36-pole S-02020201-0900 (not part of the module)
Analogue inputs	8
Resolution	16 bit (resistance 0.01 Ω , temperature 0.1°C)
Pt100 measuring range	- 75°C...+ 670°C
Ni100 measuring range	- 60°C...+ 250°C
Resistance	70...330 Ω
Temperature drift	< \pm 50 ppm/°C regarding range limit
Critical frequency	typical 2 Hz
Measurement current	< 0.50 mA
Sampling frequency	> 3.88 Hz (if all channels are enabled)
Controller	ASIC ET1200
Baud rate	100 Mbit/s
E-bus port	10-pin system plug in side wall
Term. module	not required
Power supply	24 V DC -20% +25%
E-bus load	170 mA
UL approval	

8.3. Analogue temperature inputs AI4-THERMO 16BIT

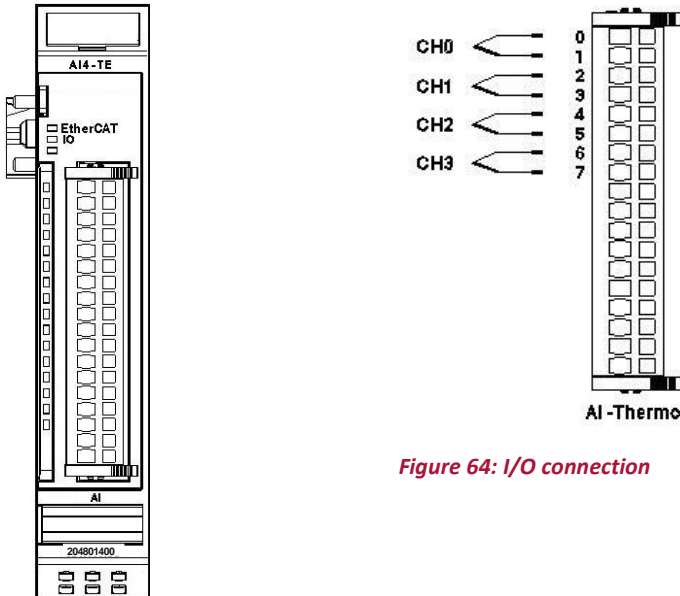

Figure 63: Front view of AI4-THERMO I/O module

Figure 64: I/O connection

i NOTE

The AI4-THERMO module is no longer recommended for new projects. Please use the successive AI4-PT/NI/THERMO 16BIT CoE module.

8.3.1. Terminals

The module needs no separate 24 V connector. Power is supplied to the module through the E-bus connector.

Operative earth / shielding of analog wires □ section 3.1.1 Earth

8.3.2. Status LEDs

“EtherCAT” LED

The LED labeled “EtherCAT” indicates the state of the EtherCAT ASIC.

EtherCAT		
State	LED flash code	Explanation
Init	Red, on	Initializing, no data exchange
Pre-Op	Red/green, 1:1	Pre-operational, no data exchange
Safe-Op	Red/green, 5:1	Safe operation, inputs readable
Op	Green, on	Operational, unrestricted data exchange

“I/O” LED

The LED labeled “I/O” indicates the state of the module's I/Os.

I/O		
State	LED flash code	Explanation
Ok	Green, on	No error
Error	Off	Malfunction of module if E-bus LED = On Inoperative if E-bus LED = Off
	Red, 4x	EtherCAT watchdog control
	Red, 6x	Module-specific fault
	Red, 7x	Configuration error (E-bus pre-operational), no. of process data differs from that in the module
Defective	Red, on	Module defective

“Power” LED

There is no LED labeled “Power” because a separate power feed is not required.

“Channel” LEDs

Channel		
State	LED flash code	Explanation
On	Green, on	Channel enabled
Off	Off	Channel disabled
Error	Red	Measuring value is out of range

8.3.3. Function

Module AI4-THERMO has 4 analogue inputs for thermo-element sensors. It can also measure mV-voltages.

The letter 'n' in the tables below represents the channel number (n=0...3).

Analogue inputs

Check the following variable for the digitized input values:

Inputs			
Variable	Data type	Explanation	
Channel_n	INT	Measuring value of channel n (n = 0...3)	
		mV-Mode	in μV resp. 2 μV
		Default	in 1/10 °C

Module control

The module provides you with various operational options.

To set up the module choose the options as appropriate and accept by setting control bit “SetOptions” to a rising edge. The module will confirm by returning “OptionsSet”.

There are various “module error” bits that the module uses to indicate errors. The states of the error bits are retained and also used for error indication by the “I/O” LED.

To reset the error bits set control bit “ResetError” to a rising edge.

Error bits		
Variable	Data type	Explanation
SetOptions	BOOL	Rising edge <input type="checkbox"/> accepts module options
ResetError	BOOL	Rising edge <input type="checkbox"/> acknowledges error

Module options

The following options are available for module AI4-THERMO:

Module options			
Variable	Data type	Explanation	
Channel_n_SensorType	USINT	Sensor type	
		16#00	mV: not used
		16#10	mV: -40 ..+65 mV, values in 2 µV
		16#04	Type K: not used
		16#14	Type K: -200°C .. +1372°C in 0.1°C
Channel_n_On	BOOL	Enable channel n	
Channel_n_Filter	USINT	Set filter for channel n The arithmetic mean is output after n+1 conversions.	
n		0 ... 3 Channel number	

To set and accept options, see Module control

Module state

The following module states are indicated:

Module state		
Variable	Data type	Explanation
Shortcut	BOOL	Not used
Undervoltage	BOOL	Not used
Watchdog	BOOL	Internal watchdog of module
EtherCAT_Error	BOOL	Configuration error or watchdog control
Specific_Error	BOOL	Module-specific fault
OptionsSet	BOOL	Sent by module to acknowledge SetOptions

To reset the messages, see Module control

Module-specific messages

Apart from the module error messages, there is a set of messages containing details about the current state of the module:

Messages		
Variable	Data type	Explanation
Channel_n_Out_of_Range	BOOL	Measuring value is out of range.

These messages are automatically reset when the state concerned has returned to normal. They are combined into a single "Specific_Error" state of the module and output to the I/O LED as "module-specific error".

Conversion time

The analogue signals are converted one by one down every channel. Disabling one or several channels will shorten the entire A/D conversion cycle.

'Filter' in this case means to compute an average when the set filter time is over. Analogue value conversion runs cyclically and is not synchronized with the receipt of EtherCAT telegrams. The cycle consists of the analogue value conversion plus transmitting the values into the EtherCAT data area.

Channel	
Number of channels	Cycle time in ms (all filters=0)
1	35
2	67
3	99
4	131

i NOTE

If you are aiming for a high sampling frequency, the EtherCAT master should do the filtering (averaging) because it will normally have much more processing power.

i NOTE

Take the EtherCAT cycle into account to assess how much the values stored by the EtherCAT master are up-to-date. The module described in this section will accept the above times as the ideal EtherCAT cycle setup.

Quality of analogue values**i NOTE**

Best results are obtained by connecting the shield of the signal cables to operative earth.

8.3.4. Technical data**AI4-THERMO**

Label	MC-I/O AI4-THERMO 16BIT
Part no.	204801400
Plug-in connector	18-pole S-02020201-0800 (not part of the module)
Analogue inputs	4
Resolution	16 bit
mV measuring range	mV: -40 ..+65 mV, values in 2 μ V
Type K measuring range	Typ K: -200°C .. +1372°C in 0.1°C
Measurement failure 25°C	< \pm 0.4% regarding range limit
Less measurement failure	on demand
Cold junction compensation	yes
Critical frequency	typical 0.33 Hz
Sampling frequency	> 7.63 Hz (if all channels are enabled)
Controller	ASIC ET1200
Baud rate	100 Mbit/s
E-bus port	10-pin system plug in side wall
Term. module	not required
Power supply	24 V DC -20% +25%
E-bus load	150 mA
UL approval	

8.4. Analogue temperature inputs AI4-PT/NI/THERMO 16BIT CoE

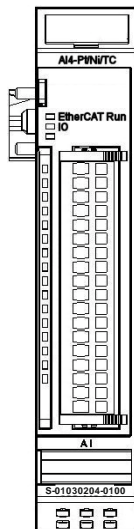

Figure 65: Front view of AI4-PT/NI/THERMO 16BIT CoE I/O module

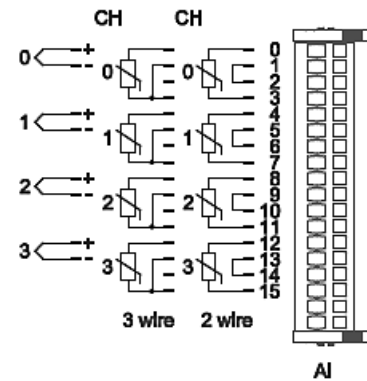

Figure 66: I/O connection

i NOTE

Module AI4-PT/NI/THERMO 16BIT CoE is the incompatible successor to the modules AI4-PT/NI100, AI4-PT/NI1000 and AI4-THERMO.

Before replacing an AI4-PT/NI100 or AI4-PT/NI1000 or AI4-THERMO with an AI4-PT/NI/THERMO 16BIT CoE module, you must modify the EtherCAT master's control program.

8.4.1. Terminals

The module needs no separate 24 V connector. Power is supplied to the module through the E-bus connector.

Operative earth / shielding of analog wires □ section 3.1.1 Earth

8.4.2. Status LEDs

“EtherCAT” LED

The LED labeled “EtherCAT” indicates the state of the EtherCAT ASIC.

EtherCAT		
State	LED flash code	Explanation
Init	Red, on	Initializing, no data exchange
Pre-Op	Red/green, 1:1	Pre-operational, no data exchange
Safe-Op	Red/green, 5:1	Safe operation, inputs readable
Op	Green, on	Operational, unrestricted data exchange

“I/O” LED

The LED labeled “I/O” indicates the state of the module’s I/Os.

I/O		
State	LED flash code	Explanation
Ok	Green, on	No error
Error	Off	Malfunction of module if E-bus LED = On
		Inoperative if E-bus LED = Off
	Red, 4x	EtherCAT watchdog control
	Red, 7x	Configuration error (E-bus pre-operational), no. of process data differs from that in the module
Defective	Red, on	Module defective

“Power” LED

There is no LED labeled “Power” because a separate power feed is not required.

“Channel” LEDs

The "Channel" LEDs indicate the state of every channel.

Channel		
State	LED flash code	Explanation
On	Green, on	Channel enabled
Off	Off	Channel disabled
Error	Red 1x	Sensor low
	Red 2x	Sensor high

i NOTE**Note on PT100/NI100 mode**

Error "input high" is not shown in the PT100 and NI100 modes, unless a temperature sensor is connected. Check that your wiring is correct (jumped 2-wire or 3-wire connection) to ensure that all error are detected/shown properly.

i NOTE**Note on thermocouple mode**

Errors input low and input high are just indicative of the temperature being out of the set range.

A short circuit (input low) is not detected in thermocouple mode (types J,K) because the thermal voltage is too small for a short circuit to be relevant to the measured result.

Since a broken wire is not detected, the floating module values may provoke an indication of error input high or input low.

Function

Module AI4-PT/NI/THERMO 16BIT CoE features 4 analogue inputs for temperature sensors. Every channel can be separately set to one of the following sensor types: millivolt, PT100, PT1000, NI100, NI1000 (DIN 43760) or thermocouple.

Measured value

Readings are shown in 0.1 °C steps (default). Or you can choose to show them as Ohm/Volt or raw data.

Module options

Conversion of the analogue values can be synchronized with DC (Distributed Clocks) or SM (Sync Manager).

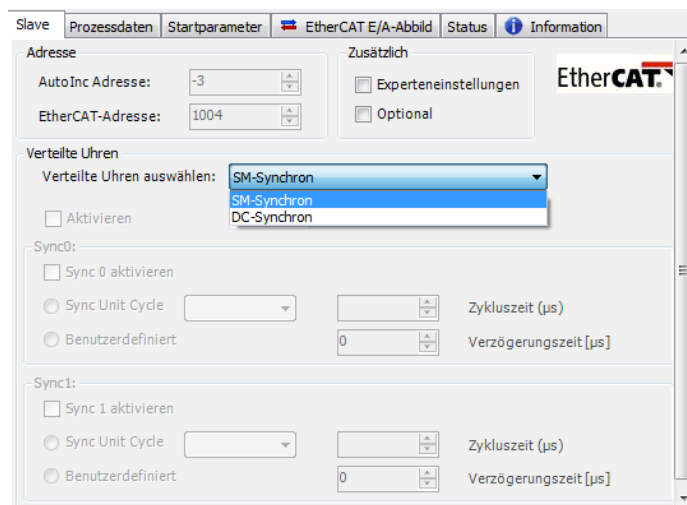

Figure 67: Module options

The process data objects stored as variables in the EtherCAT master's control program are used to access the input values and the module state.

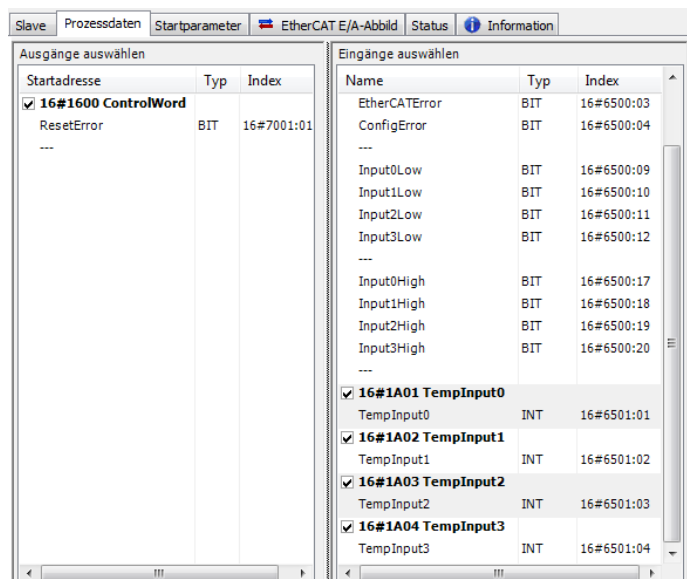

Figure 68: Process data

Service data objects (SDO) are available for details and settings.

You may run the configuration tool offline and choose the "Startup Parameters" to change some settings of module AI4-Pt/Ni/TC (such as the properties of each of the inputs). The EtherCAT master will apply the settings when starting up the module.

You can also use the SDO transfer components available for the EtherCAT master to change settings at runtime.

Click/tap on "Add...", choose an object, and set the appropriate value.

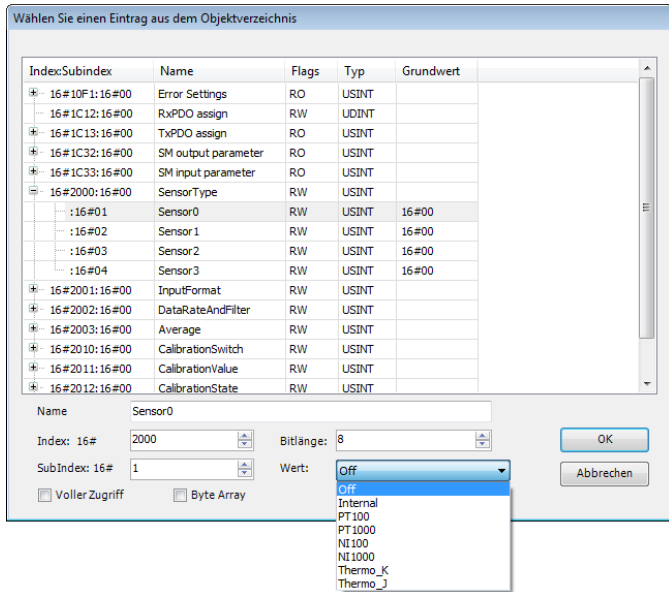

Figure 69: Object dictionary

You can set up the following options for every channel:

Module options		
Name	Value	Explanation
SensorType	0	Off (default)
	1	Internal (mV)
	2	PT100
	3	PT1000
	4	NI100
	5	NI1000 (DIN43760)
	6	Thermo K
	7	Thermo J
InputFormat	0	0.1 °C
	1	Ω / V
	2	Raw (raw data)

Data rate und Filter	0	1000 readings per second
	1	600 readings per second
	2	330 readings per second
	3	175 readings per second
	4	90 readings per second
	5	45 readings per second
	6	20 readings per second
	7	20 readings per second plus 50 & 60 Hz filter
	8	20 readings per second plus 50 Hz filter
	9	20 readings per second plus 60 Hz filter
Average	n=1...255	Inputn=average after n cycles (default=1)

StateWord

The state word (DWORD) is indicative of the module state:

StateWord		
Bit	Name	Explanation
0	ResetErrorAck	Acknowledges "Reset Error" in Module Control
1	-	not used
2	EtherCATErr	Sync Manager Watchdog
3	ConfigError	Mismatch of Sync Manager's quantity structure
4-7	-	not used
8	Input0low	Incorrect range of connected reading
9	Input1low	Incorrect range of connected reading
10	Input2low	Incorrect range of connected reading
11	Input3low	Incorrect range of connected reading
12-15	-	not used
16	Input0high	Incorrect range of connected reading
17	Input1high	Incorrect range of connected reading
18	Input2high	Incorrect range of connected reading
19	Input3high	Incorrect range of connected reading
20-31	-	not used

Analogue inputs

Check the following variables for the digitized input values:

Inputs		
Variable	Data type	Explanation
TempInputn	INT	Value of channel n (n=0...3) in 0.1 °C, Ω or 2 μV

ControlWord

The control word contains a bit for acknowledging errors.

ControlWord		
Bit	Name	Explanation
0	ResetError	0 -> errors are retained, 1 -> errors cleared after removing their cause
1-15	-	not used

Cold point compensation

Cold points are automatically compensated if thermocouples are used. Temperature readings are taken immediately at the plug near the connections.

Calibration

This module need not be calibrated by the end user because it is calibrated after fabrication.

It can only be calibrated once because the calibration values are kept on memory.

The calibration objects (2010:n; 2011:n and 2012:n) in the "Startup Parameters" are intended for internal use only.

Object dictionary

Index	Name	Type	Default	Min Max	Access
1000	Device Type	UINT32	0x40191		RO
1001	Error Register	UINT8			RO
1008	Device Name	String	AI4_Pt/Ni/Thermo		RO
1009	Hardware Version	String	1.00		RO
100A	Software Version	String	1.00		RO
1018	Identity Object	Array			
1018, 0	Number of Entries	UINT8	4		RO
1018, 1	Vendor Id	UINT32	0x0048554B		RO
1018, 2	Product Code	UINT32	185345		RO
1018, 3	Revision Number	UINT32	1		RO
1018, 4	Serial Number	UINT32			RO
2000	Sensor Type	Array			
2000, 0	Number of Entries	UINT8	4		RO
2000, 1	Sensor0	UINT8	Off	Off (0), Internal (1), PT100 (2), PT1000 (3), NI100 (4), NI1000 (5), Thermo_K (6), Thermo_J (7),	RW
2000, 2	Sensor1	UINT8	Off	Off, Internal, PT100, PT1000, NI100, NI1000, Thermo_K, Thermo_J,	RW
2000, 3	Sensor2	UINT8	Off	Off, Internal, PT100, PT1000, NI100, NI1000, Thermo_K, Thermo_J,	RW
2000, 4	Sensor3	UINT8	Off	Off, Internal, PT100, PT1000, NI100, NI1000, Thermo_K, Thermo_J,	RW
2001	Input Format	Array			

Index	Name	Type	Default	Min Max	Access
2001, 0	Number of Entries	UINT8	4		RO
2001, 1	Input0Format	UINT8	0.1°C	0.1°C (0), Ω / V (1) Raw (2)	RW
2001, 2	Input1Format	UINT8	0.1°C	0.1°C, Ω / V Raw	RW
2001, 3	Input2Format	UINT8	0.1°C	0.1°C, Ω / V Raw	RW
2001, 4	Input3Format	UINT8	0.1°C	0.1°C, Ω / V Raw	RW
2002	Data RateAndFilter	Array			
2002, 0	Number of Entries	UINT8	4		
2002, 1	Input0DataRateAnd Filter	UINT8	20 PLC	1000 PLC (0) 600 PLC (1) 330 PLC (2) 175 PLC (3) 90 PLC (4) 45 PLC (5) 20 PLC (6) 20 PLC+50&60Hz (7) 20 PLC + 50Hz (8) 20 PLC + 60Hz (9)	RO
2002, 2	Input1DataRateAndFilter	UINT8	20 PLC	1000 PLC 600 PLC 330 PLC 175 PLC 90 PLC 45 PLC 20 PLC 20 PLC+50&60Hz 20 PLC + 50Hz 20 PLC + 60Hz	RO
2002, 3	Input2DataRateAndFilter	UINT8	20 PLC	1000 PLC 600 PLC 330 PLC 175 PLC 90 PLC 45 PLC 20 PLC 20 PLC+50&60Hz 20 PLC + 50Hz 20 PLC + 60Hz	RO
2002, 4	Input3DataRateAndFilter	UINT8	20 PLC	1000 PLC 600 PLC 330 PLC 175 PLC	RO

Index	Name	Type	Default	Min Max	Access
				90 PLC 45 PLC 20 PLC 20 PLC+50&60Hz 20 PLC + 50Hz 20 PLC + 60Hz	
2003	Average	Array			
2003, 0	Number of Entries	UINT8	4		RO
2003, 1	Input 0 Average	UINT8	1	1..255	RW
2003, 2	Input 1 Average	UINT8	1	1..255	RW
2003, 3	Input 2 Average	UINT8	1	1..255	RW
2003, 4	Input 3 Average	UINT8	1	1..255	RW
6401	Analogue input	Array			
6401, 0	Number of Entries	UINT8	4		RO
6401, 1	Analog Input 0	UINT16			RO P
6401, 2	Analog Input 1	UINT16			RO P
6401, 3	Analog Input 2	UINT16			RO P
6500	StateWord	Array			RO P
6500, 0	Number of Entries	UINT8	32		RO P
6500, 1	ResetErrorAck	BOOL			RO P
6500, 2	-	BOOL			RO P
6500, 3	EtherCAT Error	BOOL			RO P
6500, 4	ConfigError	BOOL			RO P
6500, 5..8	-	BOOL			RO P
6500, 9	Input 0 low	BOOL			RO P
6500, 10	Input 1 low	BOOL			RO P
6500, 11	Input 2 low	BOOL			RO P
6500, 12	Input 3 low	BOOL			RO P
6500, 13..16	-	BOOL			RO P
6500, 17	Input 0 high	BOOL			RO P
6500, 18	Input 1 high	BOOL			RO P
6500, 19	Input 2 high	BOOL			RO P
6500, 20	Input 3 high	BOOL			RO P
6500, 21..32	-	BOOL			RO P
7001	Module Control	Array			
7001, 0	Number of Entries	UINT8	1		RO
7001, 1	Reset Error	BOOL			RW P

RO=read-only, RW= read/write, P=process image

8.4.3. Technical data

AI4-PT/NI/THERMO 16BIT CoE	
Label	MC-I/O AI4-PT/NI/THERMO 16BIT CoE
Part no.	S-01030204-0100
Analogue inputs	4
Resolution	16 bit
Input filter cutoff frequency	0.33 Hz (typ.)
Conversion time	50 ms (adjustable)
Measuring error	< $\pm 0,54$ % (of final measuring range value)
Temperature drift	< ± 50 ppm (of final measuring range value)
Thermocouple	
Sensor types	J,K, mV (internal)
Cold point compensation	Yes
Measuring range Type K	-200 °C...+1372 °C
Measuring range Type J	-50 °C...+760 °C
Measuring range mV	-40 ... +65 mV
PT100 / NI100	
Measuring range PT	-75 °C...+670 °C
Measuring range NI	-60 °C...+250 °C
Input resistance	70...320 Ω
Measuring current	1 mA (typ.)
PT1000 / NI1000DIN43760	
Measuring range PT	-75 °C...+670 °C
Measuring range NI	-60 °C...+250 °C
Input resistance	700...3200 Ω
Measuring current	0.1 mA (typ.)
General	
Baud rate	100 Mbit/s
Controller	ASIC ET1200
E-bus port	10-pin system plug in side wall
Term. module	not required
Plug-in connector	18-pole S-02020201-0800 (not part of the module)

AI4-PT/NI/THERMO 16BIT CoE

Power supply	None
E-bus load	170 mA
UL approval	

8.5. Analogue temperature inputs AI8-PT/NI/THERMO 16BIT CoE

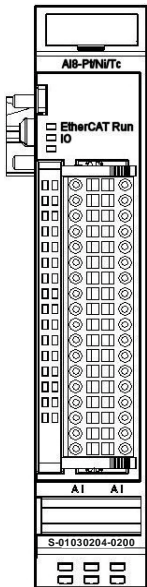

Figure 70: Front view of AI8-PT/NI/THERMO 16BIT CoE I/O module

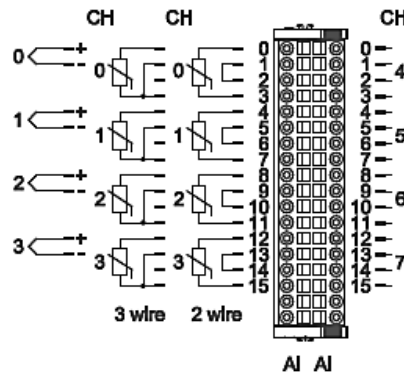

Figure 71: I/O connection

i NOTE

Module AI8-PT/NI/THERMO 16BIT CoE is the incompatible successor to the module AI8-PT/NI100. Before replacing an AI8-PT/NI100 with an AI8-PT/NI/THERMO 16BIT CoE module, you must modify the EtherCAT master's control program.

8.5.1. Terminals

The module needs no separate 24 V connector. Power is supplied to the module through the E-bus connector.

Operative earth / shielding of analog wires □ section 3.1.1 Earth

8.5.2. Status LEDs

“EtherCAT” LED

The LED labeled “EtherCAT” indicates the state of the EtherCAT ASIC.

EtherCAT		
State	LED flash code	Explanation
Init	Red, on	Initializing, no data exchange
Pre-Op	Red/green, 1:1	Pre-operational, no data exchange
Safe-Op	Red/green, 5:1	Safe operation, inputs readable
Op	Green, on	Operational, unrestricted data exchange

“I/O” LED

The LED labeled “I/O” indicates the state of the module's I/Os.

I/O		
State	LED flash code	Explanation
Ok	Green, on	No error
Error	Off	Malfunction of module if E-bus LED = On Inoperative if E-bus LED = Off
	Red, 4x	EtherCAT watchdog control
	Red, 7x	Configuration error (E-bus pre-operational), no. of process data differs from that in the module
Defective	Red, on	Module defective

“Power” LED

There is no LED labeled “Power” because a separate power feed is not required.

“Channel” LEDs

The "Channel" LEDs indicate the state of every channel.

Channel		
State	LED flash code	Explanation
On	Green, on	Channel enabled
Off	Off	Channel disabled
Error	Red 1x	Sensor low
	Red 2x	Sensor high

i NOTE

Note on PT100/NI100 mode

Error "input high" is not shown in the PT100 and NI100 modes, unless a temperature sensor is connected. Check that your wiring is correct (jumped 2-wire or 3-wire connection) to ensure that all error are detected/shown properly.

i NOTE

Note on thermocouple mode

Errors input low and input high are just indicative of the temperature being out of the set range. A short circuit (input low) is not detected in thermocouple mode (types J,K) because the thermal voltage is too small for a short circuit to be relevant to the measured result. Since a broken wire is not detected, the floating module values may provoke an indication of error input high or input low.

8.5.3. Function

The AI8-PT/NI/THERMO 16BIT CoE module has 8 analogue temperature sensor inputs. Every channel can be separately set to one of the following sensor types: millivolt, PT100, PT1000, NI100, NI1000 (DIN 43760) or thermocouple.

Measured value

Readings are shown in 0.1 °C steps (default). Or you can choose to show them as Ohm/Volt or raw data.

Module options

Conversion of the analogue values can be synchronized with DC (Distributed Clocks) or SM (Sync Manager).

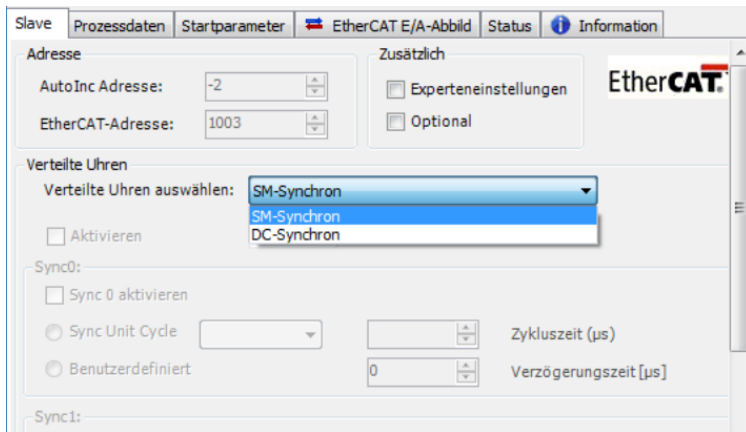

Figure 72: Module options

The process data objects stored as variables in the EtherCAT master's control program are used to access the input values and the module state.

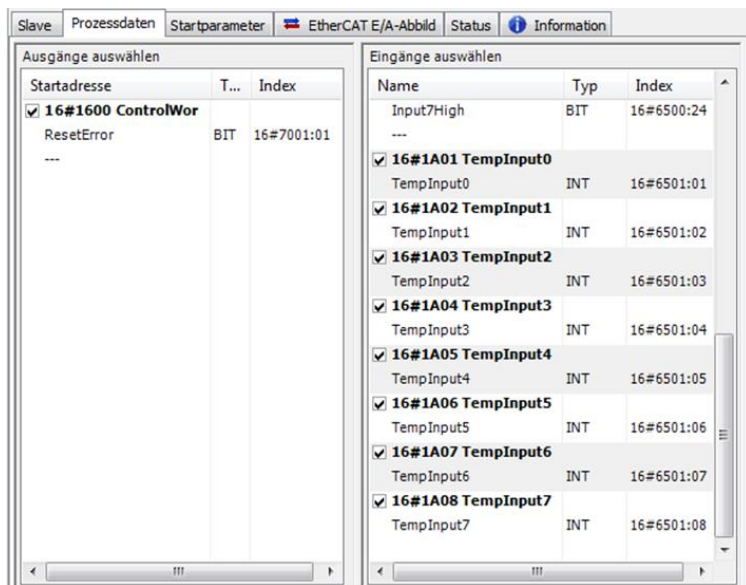

Figure 73: Process data

Service data objects (SDO) are available for details and settings.

You may run the configuration tool offline and choose the "Startup Parameters" to change some settings of module A18-PT/NI/THERMO 16BIT CoE (such as the properties of each of the inputs). The EtherCAT master will apply the settings when starting up the module.

You can also use the SDO transfer components available for the EtherCAT master to change settings at runtime.

Click/tap on "Add...", choose an object, and set the appropriate value.

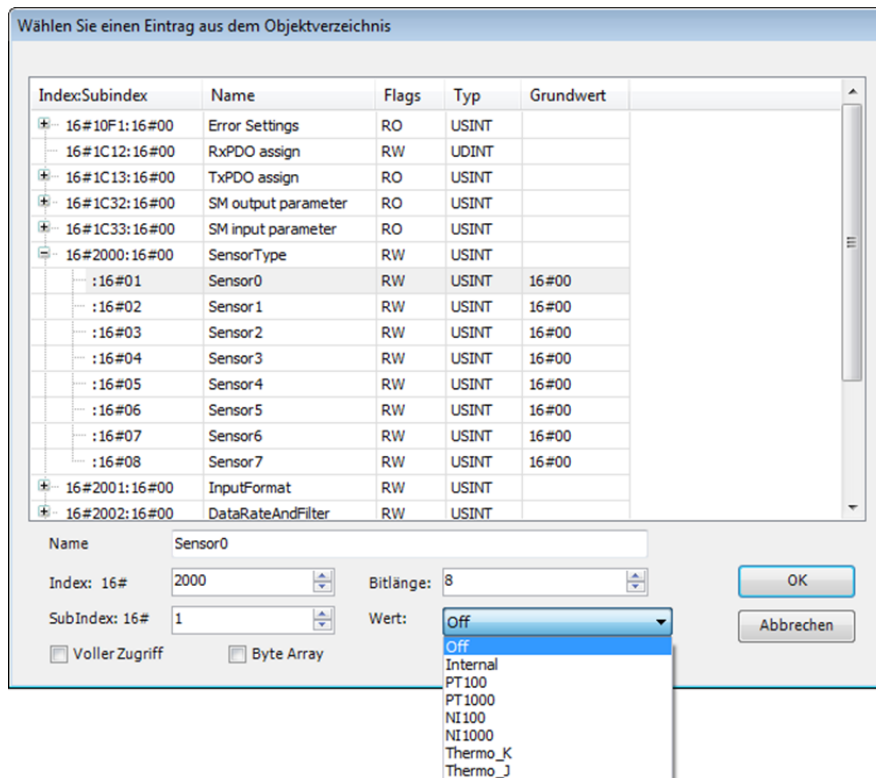

Figure 74: Object dictionary

You can set up the following options for every channel:

Module options		
Name	Value	Explanation
SensorType	0	Off (default)
	1	Internal (mV)
	2	PT100
	3	PT1000
	4	NI100
	5	NI1000 (DIN43760)
	6	Thermo K
	7	Thermo J
InputFormat	0	0.1 °C
	1	Ω / V
	2	Raw (raw data)
Data rate and filter	0	1000 readings per second
	1	600 readings per second
	2	330 readings per second
	3	175 readings per second
	4	90 readings per second
	5	45 readings per second
	6	20 readings per second
	7	20 readings per second plus 50 & 60 Hz filter
	8	20 readings per second plus 50 Hz filter
	9	20 readings per second plus 60 Hz filter
Average	n=1...255	Inputn=average after n cycles (default=1)

StateWord

The state word (DWORD) is indicative of the module state:

StateWord		
Bit	Name	Explanation
0	ResetErrorAck	Acknowledges "Reset Error" in Module Control
1	-	not used
2	EtherCATErrror	Sync Manager Watchdog
3	ConfigError	Mismatch of Sync Manager's quantity structure
4-7	-	not used
8	Input0low	Incorrect range of connected reading
9	Input1low	Incorrect range of connected reading
10	Input2low	Incorrect range of connected reading
11	Input3low	Incorrect range of connected reading
12	Input4low	Incorrect range of connected reading
13	Input5low	Incorrect range of connected reading
14	Input6low	Incorrect range of connected reading
15	Input7low	Incorrect range of connected reading
16	Input0high	Incorrect range of connected reading
17	Input1high	Incorrect range of connected reading
18	Input2high	Incorrect range of connected reading
19	Input3high	Incorrect range of connected reading
20	Input4high	Incorrect range of connected reading
21	Input5high	Incorrect range of connected reading
22	Input6high	Incorrect range of connected reading
23	Input7high	Incorrect range of connected reading
24-31	-	not used

Analogue inputs

Check the following variables for the digitized input values:

Inputs		
Variable	Data type	Explanation
TempInputn	INT	Value of channel n (n=0...7) in 0.1 °C, Ω or 2 μV

ControlWord

The control word contains a bit for acknowledging errors.

ControlWord		
Bit	Name	Explanation
0	ResetError	0 -> errors are retained, 1 -> errors cleared after removing their cause
1-15	-	not used

Cold point compensation

Cold points are automatically compensated if thermocouples are used. Temperature readings are taken immediately at the plug near the connections.

Calibration

This module need not be calibrated by the end user because it is calibrated after fabrication.

It can only be calibrated once because the calibration values are kept on memory.

The calibration objects (2010:n; 2011:n and 2012:n) in the "Startup Parameters" are intended for internal use only.

Object dictionary

Index	Name	Type	Default	Min Max	Access
1000	Device Type	UINT32	0x40191		RO
1001	Error Register	UINT8			RO
1008	Device Name	String	AI8_Pt/Ni/Thermo		RO
1009	Hardware Version	String	1.00		RO
100A	Software Version	String	1.00		RO
1018	Identity Object	Array			
1018, 0	Number of Entries	UINT8	4		RO
1018, 1	Vendor Id	UINT32	0x0048554B		RO
1018, 2	Product Code	UINT32	185346		RO
1018, 3	Revision Number	UINT32	1		RO
1018, 4	Serial Number	UINT32			RO
2000	Sensor Type	Array			
2000, 0	Number of Entries	UINT8	8		RO
2000, 1	Sensor0	UINT8	Off	Off (0), Internal (1), PT100 (2), PT1000 (3), NI100 (4), NI1000 (5), Thermo_K (6), Thermo_J (7),	RW
2000, 2	Sensor1	UINT8	Off	Off, Internal, PT100, PT1000, NI100, NI1000, Thermo_K, Thermo_J,	RW
2000, 3	Sensor2	UINT8	Off	Off, Internal, PT100, PT1000, NI100, NI1000, Thermo_K, Thermo_J,	RW
2000, 4	Sensor3	UINT8	Off	Off, Internal, PT100, PT1000, NI100, NI1000, Thermo_K, Thermo_J,	RW
2000, 5	Sensor4	UINT8	Off	Off,	RW

Index	Name	Type	Default	Min Max	Access
				Internal, PT100, PT1000, NI100, NI1000, Thermo_K, Thermo_J,	
2000, 6	Sensor5	UINT8	Off	Off, Internal, PT100, PT1000, NI100, NI1000, Thermo_K, Thermo_J,	RW
2000, 7	Sensor6	UINT8	Off	Off, Internal, PT100, PT1000, NI100, NI1000, Thermo_K, Thermo_J,	RW
2000, 8	Sensor7	UINT8	Off	Off, Internal, PT100, PT1000, NI100, NI1000, Thermo_K, Thermo_J,	RW
2001	Input Format	Array			
2001, 0	Number of Entries	UINT8	8		RO
2001, 1	Input0Format	UINT8	0.1°C	0.1°C (0), Ω / V (1) Raw (2)	RW
2001, 2	Input1Format	UINT8	0.1°C	0.1°C, Ω / V Raw	RW
2001, 3	Input2Format	UINT8	0.1°C	0.1°C, Ω / V Raw	RW
2001, 4	Input3Format	UINT8	0.1°C	0.1°C, Ω / V Raw	RW
2001, 5	Input4Format	UINT8	0.1°C	0.1°C, Ω / V Raw	RW
2001, 6	Input5Format	UINT8	0.1°C	0.1°C,	RW

Index	Name	Type	Default	Min Max	Access
				Ω / V Raw	
2001, 7	Input6Format	UINT8	0.1°C	0.1°C, Ω / V Raw	RW
2001, 8	Input Format	UINT8	0.1°C	0.1°C, Ω / V Raw	RW
2002	Data RateAndFilter	Array			
2002, 0	Number of Entries	UINT8	8		
2002, 1	Input0DataRateAnd Filter	UINT8	20 PLC	1000 PLC (0) 600 PLC (1) 330 PLC (2) 175 PLC (3) 90 PLC (4) 45 PLC (5) 20 PLC (6) 20 PLC+50&60Hz (7) 20 PLC + 50Hz (8) 20 PLC + 60Hz (9)	RO
2002, 2	Input1DataRateAndFilter	UINT8	20 PLC	1000 PLC 600 PLC 330 PLC 175 PLC 90 PLC 45 PLC 20 PLC 20 PLC+50&60Hz 20 PLC + 50Hz 20 PLC + 60Hz	RO
2002, 3	Input2DataRateAndFilter	UINT8	20 PLC	1000 PLC 600 PLC 330 PLC 175 PLC 90 PLC 45 PLC 20 PLC 20 PLC+50&60Hz 20 PLC + 50Hz 20 PLC + 60Hz	RO
2002, 4	Input3DataRateAndFilter	UINT8	20 PLC	1000 PLC 600 PLC 330 PLC 175 PLC 90 PLC 45 PLC 20 PLC 20 PLC+50&60Hz 20 PLC + 50Hz	RO

Index	Name	Type	Default	Min Max	Access
2002, 5	Input4DataRateAndFilter	UINT8	20PLC	20 PLC + 60Hz 1000PLC 600PLC 330PLC 175 PLC 90 PLC 45 PLC 20 PLC 20 PLC+50&60Hz 20 PLC + 50Hz 20 PLC + 60Hz	RO
2002, 6	Input5DataRateAnd Filter	UINT8	20 PLC	1000 PLC 600 PLC 330 PLC 175 PLC 90 PLC 45 PLC 20 PLC 20 PLC+50&60Hz 20 PLC + 50Hz 20 PLC + 60Hz	RO
2002, 7	Input6DataRateAndFilter	UINT8	20 PLC	1000 PLC 600 PLC 330 PLC 175 PLC 90 PLC 45 PLC 20 PLC 20 PLC+50&60Hz 20 PLC + 50Hz 20 PLC + 60Hz	RO
2002, 8	Input7DataRateandFilter	UINT8	20 PLC	1000 PLC 600 PLC 330 PLC 175 PLC 90 PLC 45 PLC 20 PLC 20 PLC+50&60Hz 20 PLC + 50Hz 20 PLC + 60Hz	RO
2003	Average	Array			
2003, 0	Number of Entries	UINT8	8		RO
2003, 1	Input 0 Average	UINT8	1	1..255	RW
2003, 2	Input 1 Average	UINT8	1	1..255	RW
2003, 3	Input 2 Average	UINT8	1	1..255	RW
2003, 4	Input 3 Average	UINT8	1	1..255	RW
2003, 5	Input 4 Average	UINT8	1	1..255	RW
2003, 6	Input 5 Average	UINT8	1	1..255	RW

Index	Name	Type	Default	Min Max	Access
2003, 7	Input 6 Average	UINT8	1	1..255	RW
2003, 8	Input 7 Average	UINT8	1	1..255	RW
6401	Analogue input	Array			
6401, 0	Number of Entries	UINT8	8		RO
6401, 1	Analog Input 0	UINT16			RO P
6401, 2	Analog Input 1	UINT16			RO P
6401, 3	Analog Input 2	UINT16			RO P
6401, 4	Analog Input 3	UINT16			RO P
6401, 5	Analog Input 4	UINT16			RO P
6401, 6	Analog Input 5	UINT16			RO P
6401, 7	Analog Input 6	UINT16			RO P
6401, 8	Analog Input 7	UINT16			RO P
6500	StateWord	Array			
6500, 0	Number of Entries	UINT8	32		RO
6500, 1	ResetErrorAck	BOOL			RO P
6500, 2	-	BOOL			RO P
6500, 3	EtherCAT Error	BOOL			RO P
6500, 4	ConfigError	BOOL			RO P
6500, 5..8	-	BOOL			RO P
6500, 9	Input 0 low	BOOL			RO P
6500, 10	Input 1 low	BOOL			RO P
6500, 11	Input 2 low	BOOL			RO P
6500, 12	Input 3 low	BOOL			RO P
6500, 13	Input 4 low	BOOL			RO P
6500, 14	Input 5 low	BOOL			RO P
6500, 15	Input 6 low	BOOL			RO P
6500, 16	Input 7 low	BOOL			RO P
6500, 17	Input 0 high	BOOL			RO P
6500, 18	Input 1 high	BOOL			RO P
6500, 19	Input 2 high	BOOL			RO P
6500, 20	Input 3 high	BOOL			RO P
6500, 21	Input 4 high	BOOL			RO P
6500, 22	Input 5 high	BOOL			RO P
6500, 23	Input 6 high	BOOL			RO P
6500, 24	Input 7 high	BOOL			RO P
6500, 25..32	ResetErrorAck	BOOL			RO P
6500, 1	EtherCAT Error	BOOL			RO P
6500, 3	ConfigError	BOOL			RO P
6500, 4	Module Control	Array			
7001	Number of Entries	UINT8	1		RO
7001, 0	Reset Error	BOOL			RW P
7001, 1					

RO=read-only, RW= read/write, P=process image

8.5.4. Technical data

AI8-PT/NI/THERMO 16BIT CoE	
Label	MC-I/O AI8-PT/NI/THERMO 16BIT CoE
Part no.	S-01030204-0200
Analogue inputs	8
Resolution	16 bit
Input filter cutoff frequency	0.33 Hz (typ.)
Conversion time	50 ms (adjustable)
Measuring error	< ±0,54 % (of final measuring range value)
Temperature drift	< ±50 ppm (of final measuring range value)
Thermocouple	
Sensor types	J,K, mV (internal)
Cold point compensation	Yes
Measuring range Type K	-200 °C...+1372 °C
Measuring range Type J	-50 °C...+760 °C
Measuring range mV	-40 ... +65 mV
PT100 / NI100	
Measuring range PT	-75 °C...+670 °C
Measuring range NI	-60 °C...+250 °C
Input resistance	70...320 Ω
Measuring current	1 mA (typ.)
PT1000 / NI1000DIN43760	
Measuring range PT	-75 °C...+670 °C
Measuring range NI	-60 °C...+250 °C
Input resistance	700...3200 Ω
Measuring current	0.1 mA (typ.)
General	
Baud rate	100 Mbit/s
Controller	ASIC ET1200
E-bus port	10-pin system plug in side wall
Term. module	not required
Plug-in connector	36-pole S-02020201-0900 (not part of the module)

AI8-PT/NI/THERMO 16BIT CoE

Power supply	None
E-bus load	170 mA
UL approval	

9. Counter modules

9.1. Counters with analogues outputs COUNTER/POSI2 5V

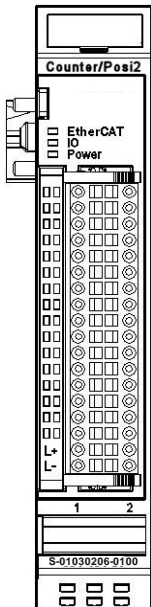

Figure 75: Front view of COUNTER/POSI2 5V I/O module

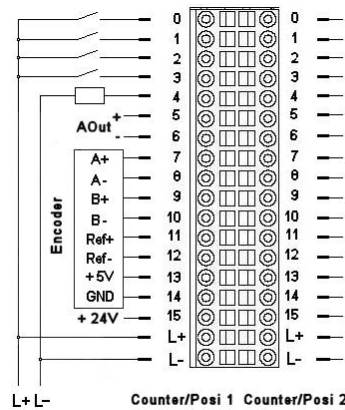

Figure 76: I/O connection

9.1.1. Terminals

COUNTER/POSI2		
Pin	Signal	Explanation
0..3	In_0..3	Digital inputs
4	Out_0	Digital output
5..6	A_Out	Analogue output (COUNTER/POSI2 only)
7..12	A, B, Ref	Encoder signals
13..14	5 V	Encoder supply 5 V (0.2 A fuse)
15	+24 V	Initiator supply +24 V (0.2 A fuse)
16..17	24 V	Module supply

Operative earth / shielding of analog wires → section 3.1.1 Earth

9.1.2. Status LEDs

“EtherCAT” LED

The LED labeled “EtherCAT” indicates the state of the EtherCAT ASIC.

EtherCAT		
State	LED flash code	Explanation
Init	Red, on	Initializing, no data exchange
Pre-Op	Red/green, 1:1	Pre-operational, no data exchange
Safe-Op	Red/green, 5:1	Safe operation, inputs readable
Op	Green, on	Operational, unrestricted data exchange

“I/O” LED

The LED labeled “I/O” indicates the state of the module's I/Os.

I/O		
State	LED flash code	Explanation
Ok	Green, on	No error
Error	Off	Malfunction of module if E-bus LED = On Inoperative if E-bus LED = Off
	Red, 2x	Low voltage
	Red, 3x	Watchdog internal
	Red, 4x	EtherCAT watchdog control
	Red, 7x	Configuration error (E-bus pre-operational), no. of process data differs from that in the module
Defective	Red, on	Module defective

“Power” LED

The LED labeled "Power" indicates the state of the I/O module's I/O power supply.

Power		
State	LED flash code	Explanation
On	Green, on	24 V DC supply ok
Off	Off	24 V DC supply not ok

Status LEDs of the I/Os

The Status LEDs of the several I/Os indicate the state of the individual digital I/Os.

Status			
Pin	Voltage	LED	Explanation
0..3	24 V	Green	Digital inputs
4	24 V	Green	Digital output
7, 9, 11	5 V	Green	Encoder signals A, B, Ref

9.1.3. Function

Each channel has terminals for one encoder and 4 digital inputs and 1 digital output.

The COUNTER/POS12 module has 1 additional analogue output.

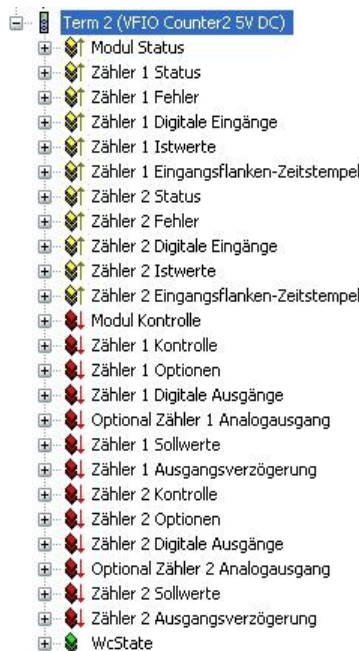

There are structured groups of variables for.

- Controlling and watching the entire module: Modul Kontrolle/Modul Status (Module control/Module status)
- Controlling and watching of Counter 1 resp. 2: Optionen/Kontrolle/Status/Fehler (Options/Control/Status/Errors)
- Counter values of Counter 1 resp. 2: Sollwerte/Istwerte (Set values/Current values)
- State of the digital I/Os of Counter 1 resp. 2: Digitale Ausgänge/Digitale Eingänge/Eingangsflanken-Zeitstempel/Ausgangsverzögerung (Digital outputs/Digital inputs/Input change time stamp/ Output delay)
- State of the analogue outputs of Counter 1 resp. 2: Optional Analogausgang (Analogue output, Function with module COUNTER/POS12 only)

Principle of control (controller) and status

If a control bit is set (=TRUE), the module will operate the corresponding function due to the rising edge of the bit.

The module indicates the execution of the function by setting the corresponding status bit (=TRUE). When the control bit is reset (=FALSE) the module will also reset the status bit (=FALSE).

i NOTE

In the following the functions of the counter module are described by Counter/Posi 1. For Counter/Posi 2 the data are valid accordingly.

Frame- or DC- synchronous mode

Dependent on whether Distributed Clocks (DC) are used or not, the module adjusts itself independently on the suitable mode of operation.

The module is preset on Frame synchronous mode. With the receipt of the first DC telegram the module is changed over to DC-synchronous mode and maintains this mode of operation up to next switching off.

Frame-synchronous

The EtherCAT master sends EtherCAT frames with the output data for the module. With the arrival of such frame the output data are taken over and processed by the module. The module places its input data into the EtherCAT frame, so that the master can receive it.

DC-synchronous

If the module is adjusted to DC-synchronous mode, it produces interrupts according to the rules of the Distributed Clocks DC.

The EtherCAT master sends also here EtherCAT Frames away with the output data for the module. With the arrival of such frames the output data of the module are taken over however then processed only if a DC interrupt has occurred. With the DC interrupt the module places its input data into a buffer, from which they are transported with the next EtherCAT Frame to the master.

With this method time-synchronous functions for digital inputs and digital outputs for several modules in one EtherCAT network are possible.

9.1.4. Controlling and watching the entire module

The module control is carried out with the variables from the group “Modul Kontrolle”. The status of the settings having been carried out becomes shown in the variables of the group “Modul Status”.

Modulkontrolle (Module Control)

The module does not have any options at present.

The module reports faults with different “Modul Status” bits. These bits are stored. They can be reset only then if the fault is not there any more. Send a rising edge to “ResetError” to reset the “Modul Status” bits.

Error bits		
Variable	Data type	Explanation
ResetError	BOOL	Rising edge <input type="checkbox"/> acknowledges error

Modulstatus (Module Status)

The following module status bits are indicated:

Module status		
Variable	Data type	Explanation
LowSupplyVoltage	BOOL	Low voltage
Watchdog	BOOL	Module internal Watchdog
EtherCAT_Error	BOOL	Configuration error or watchdog control

Acknowledgement see Module control

9.1.5. Controlling / Watching Counter 1

The setting of the functions of the counter is carried out with the variables from the group “Zähler 1 Optionen”.

The module control is carried out with the variables from the group “Zähler 1 Kontrolle”.

The status of the settings is indicated in the variables of the group “Zähler 1 Status”.

i NOTE

The use of the counter module in a variety of different applications is possible by use of the variables from the groups of Zähler 1-Optionen, -Kontrolle and -Status.

Zähler 1 Optionen (Counter 1 Options)

The module offers you different options for the operation of Counter 1. The options are set in the module with the help of the control bit “SetOptions_1” (see also

Zähler 1 **Kontrolle**) and then valid up to the next setting procedure.

- At first select the options, please. For taking over send a rising edge to the control bit “SetOptions_1”.
- The module indicates the execution by “OptionsSet_1=TRUE”.
- When “SetOptions_1” becomes FALSE again, the module responses by “OptionsSet_1=FALSE”. So the module is ready for the next setting process.

Counter 1 Options			
Variable	Data type	Value	Explanation
Enable_Compare_1	BOOL	0	Deactivate compare function
		1	Activate compare function
SelectEncoder_1	BOOL	0	A, B, Ref with detection of direction
		1	Event counter at A
			B=0 down B=1 up
SetResolution_1	BOOL		Only if SelectEncoder=1 (Event counter)
		0	Rising and falling edges
		1	Only rising edges
ControlOutput_1	BOOL	0	Output_0_0 is a regular digital output
		1	Output_0_0 is controlled by the compare function.

Zähler 1 Kontrolle (Counter 1 Control)

Enabling and disabling of counting and referencing are determined by the state of the control variables. Set and Reset functions are activated by setting of the appropriate variable. The execution is indicated in the corresponding status variable. If the control variable is reset, the counter module also resets the corresponding status variable.

Counter 1 Control			
Variable	Data type	Value	Explanation
SetOptions_1	BOOL	0/1	Take over "Zähler 1 Optionen"
ResetReferenced_1	BOOL	0/1	Reset of status bit "Referenced_1"
ResetCompared_1	BOOL	0/1	Reset of status bit "Compared_1"
ResetCaptured_1	BOOL	0/1	Reset of status bit "Captured_1"
EnableCounter_1	BOOL	0	Disable counter
		1	Enable counter
EnableReferencing_1	BOOL	0	Disable Referencing
		1	Enable Referencing
SetCounter_1	BOOL	0/1	Set counter to preset value
SetCompare_1	BOOL	0/1	Set compare value register
SetPreset_1	BOOL	0/1	Set preset value register
SetMax_1	BOOL	0/1	Set maximum value register

Zähler 1 Status (Counter 1 State)

The status variables indicate the status of the counter. This concerns the appearance of events and the indication of the execution of settings.

Counter 1 Status		
Variable	Data type	Explanation
Counting_1	BOOL	Counter is enabled
Referenced_1	BOOL	Reference function was executed, reset by ResetReferenced_1
Clockwise_1	BOOL	Counter counts up
Compared_1	BOOL	Compare function was executed, reset by ResetCompared_1
Captured_1	BOOL	Capture function was executed, reset by ResetCaptured_1
CounterSet_1	BOOL	Counter is set to preset value
CompareSet_1	BOOL	Compare value is set
PresetSet_1	BOOL	Preset value is set
MaxSet_1	BOOL	Maximum value is set
OptionsSet_1	BOOL	Options of counter 1 are set.

Zähler 1 Fehler (Counter 1 Errors)

The variables are provided for the indication of error states.

Counter 1 Errors		
Variable	Data type	Explanation
Err_Reserved_1_x	BOOL	Reserved error bits

9.1.6. Counter values of Zähler 1 (Counter 1)

Zähler 1 Sollwerte (Counter 1 Set Values)

The counter can be preset with different set values. That is done by help of the variable "SetValue_1". After setting the following control bits from the group "Zähler 1 Kontrolle" the content of "SetValue_1" will be copied as set value in the corresponding registers.

Counter 1 Set Values	
Variable	Explanation
SetCounter_1	Copy "SetValue_1" to the current counter value
SetCompare_1	Copy "SetValue_1" to the compare value register
SetPreset_1	Copy "SetValue_1" to the preset value register
SetMax_1	Copy "SetValue_1" to the maximum value register

The current set values can be read in the variable "SelectedValue" from the "Zähleristwerte" (Counter current values) group.

Select by the variable "Select_1", which value you want to see in the variable "SelectedValue".

SelectedValue			
Variable	Data type	Explanation	
Select_1	USINT	Selection which value of counter1 shall be displayed in the variable "SelectedValue".	
		0	none
		1	Vergleichswert (Compare value)
		2	Vorwahlwert (Preset value)
		3	Endwert (Max value)
		4	Fangwert (Capture value)
		5	Counter pulses/second
		6	Revolutions per minute
	128	Version info	
SetValue_1	DINT	Set value of counter 1 (source) to copy (operated by a control bit) into a set value register (target).	

Zähler 1 Istwerte (Counter 1 Actual Values)

These variables display the current counter value and the current set values. The set values are represented multiplexedly in the variable "SelectedValue" (Selection by Select_1).

Counter 1 Actual Values		
Variable	Data type	Explanation
Counter_1	DINT	Current value of counter 1
Selected_1	USINT	Selection of that value of counter 1, which is displayed in the variable SelectedValue (value of Select_1 read from the module).
		0 none
		1 Vergleichswert (Compare value)
		2 Vorwahlwert (Preset value)
		3 Endwert (Max value)
		4 Fangwert (Capture value)
		5 Counter pulses/second
		6 Revolutions per minute
		128 Version info
SelectedValue	DINT	Selected current value of counter 1

Version Info				
Byte	3	2	1	0
Explanation	Version #	Release	Level	Type code
Example	0x02	0x00	0x00	0x53
	2	0	0	S

9.1.7. Digital I/Os

Zähler 1 (Counter 1) Digital inputs

The variables indicate the status of the digital inputs.

Digital inputs		
Variable	Data type	Explanation
Input_0_0	BOOL	Digital input 0
Input_0_1	BOOL	Digital input 1
Input_0_2	BOOL	Digital input 2
Input_0_3	BOOL	Digital input 3
In_Output_0_0	BOOL	Status of digital output 0 (reads the status)

Zähler 1 (Counter 1) Input edge timestamp

The variables indicate the time, on which the status of the digital input has changed.

When the time measurement is started depends on the mode of operation (see also section 9.1.3 Frame-synchronous, DC-synchronous).

Input edge timestamp		
Variable	Data type	Explanation
Input_0_0_TS	UINT	Time stamp for digital input 0 (Hardware Capture)
Input_0_1_TS	UINT	Time stamp for digital input 1 (Software Polling)
Input_0_2_TS	UINT	Time stamp for digital input 2 (Software Polling)
Input_0_3_TS	UINT	Time stamp for digital input 3 (Software Polling)

i NOTE

The time stamp is metered between frame- or DC-interrupts and signal changes on the input in μs .

The value of the time stamp becomes to 0xFFFF, when no signal change takes place between two frame- or DC-interrupts.

In frame-synchronous mode

The time from the last frame-interrupt to the status change of the input is stored in the time stamp and sent in the following frame to the EtherCAT Master.

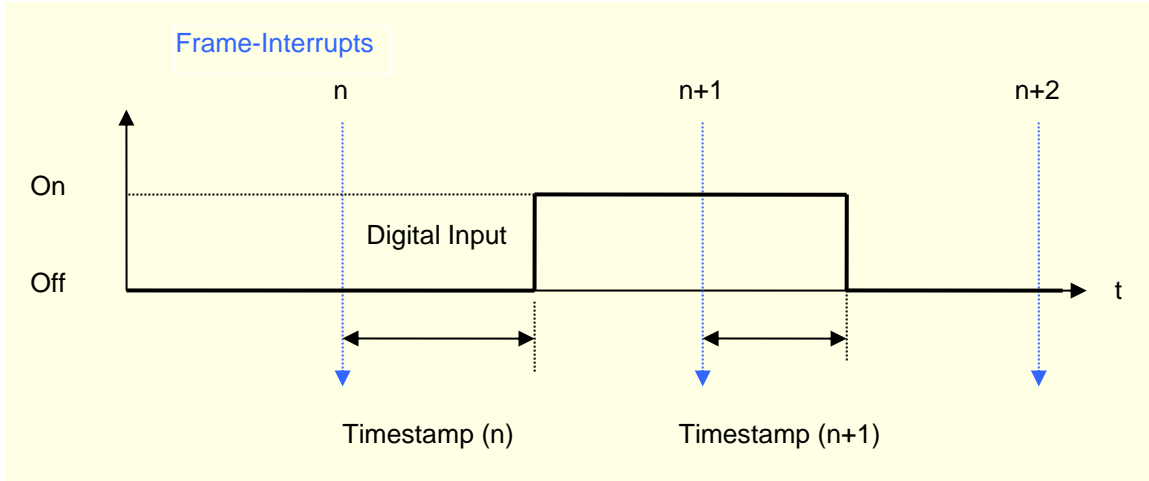

Frame-synchronous		
Frame	Digital Input	
	Variable	Time stamp
n+1	TRUE	Time stamp (n)
n+2	FALSE	Time stamp (n+1)

In DC-synchronous mode

The time from the last DC-interrupt to the status change of the input is stored in the time stamp and sent in the following frame to the EtherCAT Master.

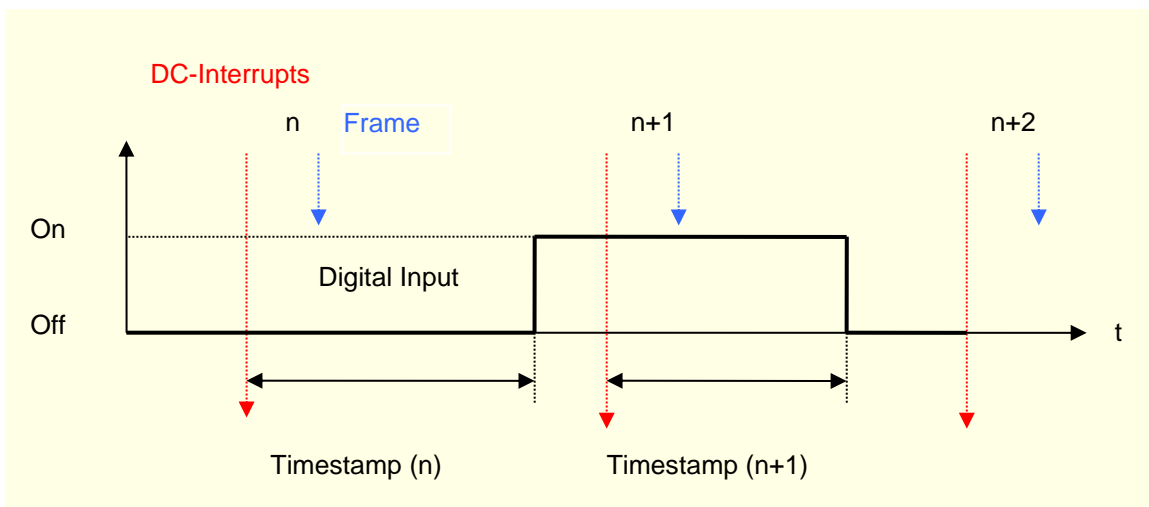

DC-synchronous		
Frame	Digital Input	
	Variable	Time stamp
n+1	TRUE	Time stamp (n)
n+2	FALSE	Time stamp (n+1)

Digital outputs

The variables indicate the status of the digital outputs.

Digital outputs		
Variable	Data type	Explanation
Output_0_0	BOOL	Digital output 0

Output set delay (in preparation)

This variable defines the time, when the output is set.

Output set delay		
Variable	Data type	Explanation
Output_0_0_Del	UINT	Output set delay in μ s

In frame-synchronous mode

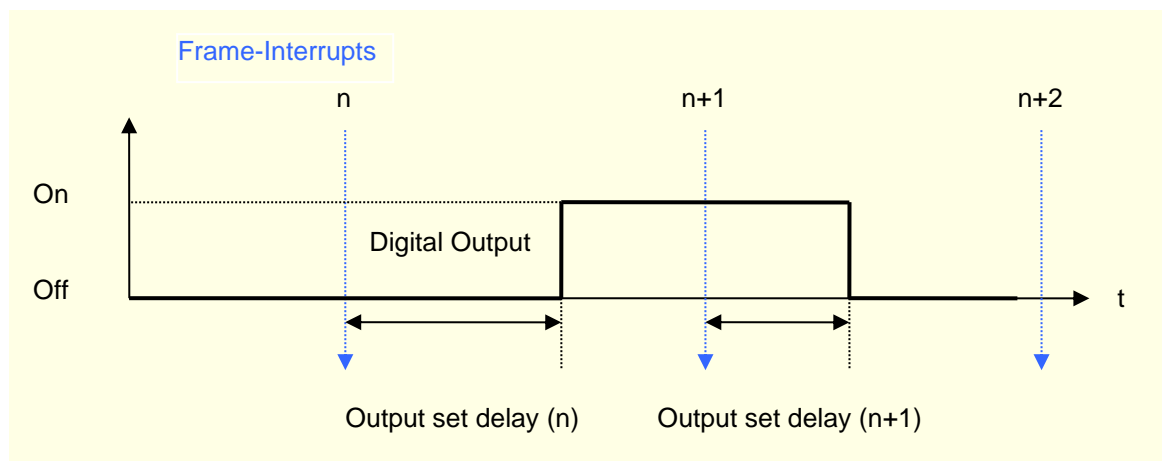

Frame-synchronous		
Frame	Digital Output	
	Variable	Output set delay
n	TRUE	Output set delay (n)
n+1	FALSE	Output set delay (n+1)

In DC-synchronous mode

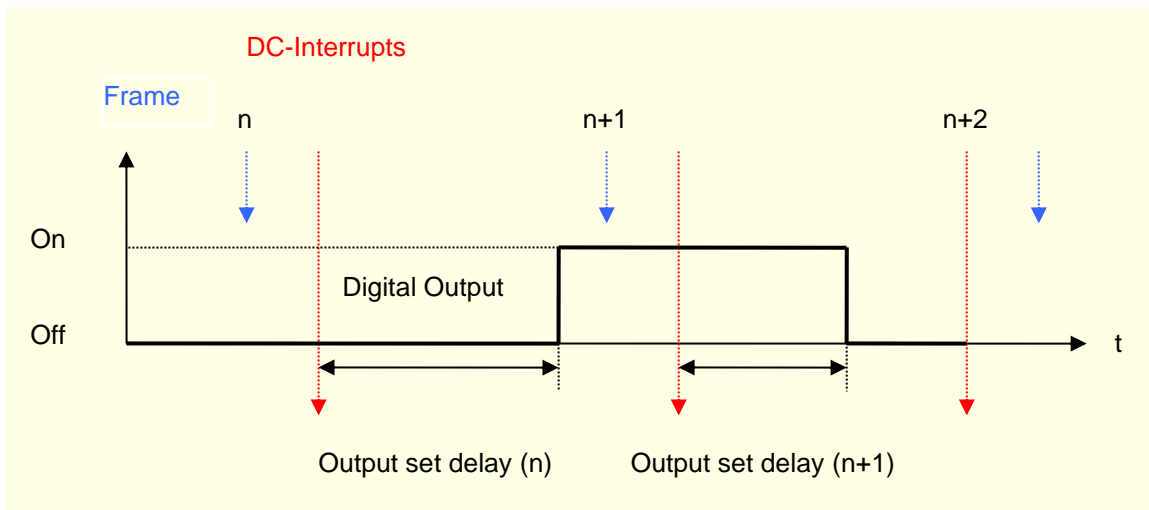

DC-synchronous		
Frame	Digital Output	
	Variable	Output set delay
n	TRUE	Output set delay (n)
n+1	FALSE	Output set delay (n+1)

9.1.8. Analogue outputs (COUNTER/POS12 5V only)

The variables define the voltage of the analogue outputs.

Analogue outputs		
Variable	Data type	Explanation
AnalogOutput_1	UINT	Analogue output 1

Output values see table voltage, page 84

9.1.9. Examples

Enable Counter

The counter is active, when the variable "EnableCounter_1" is TRUE.

```
Term2_EnableCounter_1:=TRUE;    (*Release of the counter *)
Term2_Counting_1;              (*TRUE, if counter is enabled *)
Term2_Clockwise_1;            (*Count direction, TRUE, when up *)
```

Counter set/clear

Copying the contents of "SetValue_1" into the current value is executed by a rising edge to "SetCounter_1". Execution is indicated by "CounterSet_1=TRUE".

If "SetCounter_1" is reset (FALSE) again, "CounterSet_1" also becomes FALSE again.

```
Term2_SetValue_1:=diCounterValue ;(*Copy a number into the source var*)
                                   (* 0 = Clear*)
                                   Term2_SetCounter_1:=TRUE;          (*and
                                   copy to the counter current
                                   value*)
Term2_CounterSet_1;                (*TRUE, if set*)
```

Set compare value

Configuration settings set in "Zähler 1 Optionen" are activated by the rising edge of the control bit "SetOptions_1". The successful take-over of the options is confirmed with the status bit "OptionsSet_1" (e.g. Set compare function).

PROGRAM Initialisierung (Initialization)

VAR

```
blnit: BOOL := TRUE;
Step: USINT;
```

END_VAR

IF blnit THEN

CASE Step OF

(*Select options, activate them by a rising edge to "Set_Options"*)

```
0:   Term2_EnableCounter_1:=TRUE;    (*Release counter *)
      Term2_EnableCompare_1:=TRUE;    (*Activate compare function *)
      Term2_ControlOutput_1:=TRUE;    (*Compare function controls output *)
      Term2_SetValue_1:=10000;        (*Set value = 10000..*)
      Term2_SetCompare_1:=TRUE; (*..use as compare value *)
      Term2_SetOptions_1:=TRUE;      (*Activate selected options *)
      Step:= 1;
```

(* Wait for confirmations "OptionsSet" and "CompareSet"*)

```
1:   IF Term2_OptionsSet_1 AND Term2_CompareSet_1 THEN
      Step:= 2;
    END_IF
```

(* Set "Set_Options" and "SetCompare" in the starting position*)

```

2:   Term2_SetOptions_1:=FALSE;
      Term2_SetCompare_1:=FALSE;
      Step:=0;
      bInit:=FALSE;
END_CASE
END_IF

```

Set preset value

Copying the value of "SetValue_1" into the preset value is executed by a rising edge to "SetPreset_1". The execution is indicated by "PresetSet_1=TRUE".

If "SetPreset_1" is reset (FALSE) again, "PresetSet_1" also becomes FALSE again.

```

Term2_SetValue_1:=diPresetValue ; (*Copy a number into the source var*)
Term2_SetPreset_1:=TRUE;          (*and copy to the preset value*)
Term2_PresetSet_1;                (*TRUE, if set*)

```

Set maximum value

Copying the value of "SetValue_1" into the maximum value is executed by a rising edge to "SetMax_1". The execution is indicated by "MaxSet_1=TRUE".

If "SetMax_1" is reset (FALSE) again, "MaxSet_1" also becomes FALSE again.

```

Term2_SetValue_1:=diMaxValue ;   (*Copy a number into the source var*)
Term2_SetMax_1:=TRUE;            (*and copy to the maximum value*)
Term2_MaxSet_1;                  (*TRUE, if set*)

```

Digital output

see also page 169 Zähler 1 Optionen

The digital output can be controlled optionally by the variable "Output_0_0" or the compare function.

Decision is done by the variable "ControlOutput_1" (Set options see also page 178).

The current status of the output is read from the module and displayed in "In_Output_0_0".

```

Term2_ControlOutput_1:=FALSE;    (*Term2_Output_0_0 controls output*)
Term2_ControlOutput_1:=TRUE;     (*Compare function controls output*)
Term2_In_Output_0_0;             (*Status of the output*)

```

Operating as A-B-Ref-Counter or Event Counter

see also page 169 Zähler 1 Optionen

The counter can be operated as A, B, Ref -Counter with self detection of the direction or as event counter.

The selection is done by the variable "SelectEncoder_1" (Set options see also page 178).

```

Term2_SelectEncoder_1:=FALSE;    (*A, B, Ref with
                                  self detection of the
                                  direction*)
Term2_SelectEncoder_1:=TRUE;     (*Event counter at A*)
                                  (*B=FALSE:down, B=TRUE:up*)

```

Single and multiple counting

This option is valid in the event counter mode only (see also page 169 Zähler 1 Optionen).

The counter can count edges (all rising and falling edges) or pulses (only the rising edges).
The selection is done by the variable "SetResolution_1" (Set options see also page 178).

```
Term2_SetResolution_1:=FALSE;    (*All edges*)
Term2_SetResolution_1:=TRUE;     (*Pulses*)
```

Referencing

The counter can be set to preset value when a pulse occurs at the Ref input. The preset value can be 0, but also any other 32-bit number.

Task

An encoder with 500 pulses provides 2000 increments per turn in 4-fold mode.
Every Ref pulse shall set the counter to the preset value 2000. It shall be counted down to 0 within 1 turn.
(The counting direction is determined by the turning direction of the encoder.)

PROGRAM Referenzierung (Referencing)

VAR

```
blnit: BOOL := TRUE;
Steplnit: USINT;
blnitReady: BOOL;
Step: USINT;
```

END_VAR

(*1. Initializing: Enabling of the counter and setting of the preset value*)

IF blnit THEN

 CASE Steplnit OF

(*Selecting of the options and setting them by a rising edge of "Set_Options"*)

```
    0:    Term2_EnableCounter_1:=TRUE;
          Term2_SetValue_1:=2000;
          Term2_SetPreset_1:=TRUE;
          Term2_SetOptions_1:=TRUE;
          Steplnit:=1;
```

(*Wait for confirmations "OptionsSet" and "PresetSet"*)

```
    1:    IF Term2_OptionsSet_1 AND Term2_PresetSet_1 THEN
          Steplnit:=2;
          END_IF
```

(*Reset "Set_Options" und "Set_Preset" into the start position*)

```
    2:    Term2_SetOptions_1:=FALSE;
          Term2_SetPreset_1:=FALSE;
          Steplnit:=0;
          blnit:=FALSE;
          blnitReady:=TRUE;
```

 END_CASE

END_IF

```

(*2. Controlling of the referencing*)
IF bInitReady THEN
  CASE Step OF
    (*Switch on the referencing mode*)
    0:   Term2_EnableReferencing_1:=TRUE;
        Step:=1;
    (*Wait for a referencing pulse*)
    1:   IF Term2_Referenced_1 THEN
          Step:=2;
        END_IF
    (*Reset of the referencing message*)
    2:   Term2_ResetReferenced_1:=TRUE;
        Step:=3;
    3:   IF NOT Term2_Referenced_1 THEN
          (*Exit reset of the referencing message*)
          Term2_ResetReferenced_1:=FALSE;
          (*Switch off the referencing mode*)
          Term2_EnableReferencing_1:=FALSE;
          Step:=0;   (*reference in the next turn again*)
        END_IF
    END_CASE
  END_IF

```

Capture

A falling edge at the digital input 1 can be used as trigger in order to save the current counter value (capture).

You get a message in the status bit "Captured_1" that a capture event has appeared. You have to reset "Captured_1" by "ResetCaptured_1" that the next capture event can be indicated.

```

Term2_Input_0_1;      (*Status of input 1*)
Term2_Select_1:=4;    (*Copy capture register to Term2_SelectedValue_1*)
Term2_Selected_1;     (* =4, if capture value in Term2_SelectedValue_1*)
Term2_SelectedValue_1;(*Here you can read the capture value.*)
Term2_Captured_1;     (*A capture event has appeared.*)
Term2_ResetCaptured_1; (*Reset of Term2_Captured_1*)

```

Digital inputs (Input_0_x)

The statuses of the digital inputs are indicated in the variables "Input_0_x".

Permanent additional function: The current counter value is saved in the capture register when a falling edge appears at Input_0_1.

```

Term2_Input_0_0;      (*Status of input 0*)
Term2_Input_0_1;      (*Status of input 1*)
Term2_Input_0_2;      (*Status of input 2*)
Term2_Input_0_3;      (*Status of input 3*)

```

Analogue outputs (COUNTER/POS12 5V only)

The output values of the analogue outputs are written into the variables "AnalogOutput_x".

Term2_AnalogOutput_1:= 16#7FFF; (*Set AnalogOutput_1 to +10V*)

Term2_AnalogOutput_2:= 16#8000; (*Set AnalogOutput_2 to -10V*)

Output values see table "AI4/8-U, Analogue values voltage".

9.1.10. Technical data

COUNTER/POS12 5V	
Label	MC-I/O COUNTER/POS12 5V
Part no.	S-01030206-0100
Plug-in connector	36-pole S-02020201-0900 (not part of the module)
Encoder	2 A, B, Ref
Encoder type	RS422, 5 V, 24 VDC
Count rate	RS422: 200 kHz 24 V: 200 kHz
Digital inputs	8
Input delay	1 ms
Signal level	Off: -3 ... 5 V, On: 15 V ... 30 V (EN 61131-3, Type1)
Digital outputs	2
Max. current	2 A per output
Fieldbus	EtherCAT 100 Mbit/s
EtherCAT file	Berghof EIO Modules.xml
WxHxD	25x120x90 mm
Mounting	35 mm DIN top hat rail
Controller	ASIC ET1200
E-bus port	10-pole system plug at the side wall
Term. module	not required
E-bus load	300 mA
Analogue outputs	2
Voltage	-10 V ...+10 V
Resolution	12 bit

COUNTER/POS12 5V**Power supply**

Logic	by EtherCAT coupler via E-bus plug
Power	24 V DC -20% +25%
Galvanic separation	Separated from one another and versus the bus
Storage temperature	-25 °C...+70 °C
Operating temperature	0°C...+55°C
Relative humidity	5%...95% without dewing
Protection	IP20
Interference immunity	Zone B
UL approval	

i NOTE**Encoder:**

Unused encoder signals must be connected to +5 V.

The unused encoder signals must always be connected to +5 V now, independent of frequency.

10. Interface and communication modules

10.1. Communication module CAN

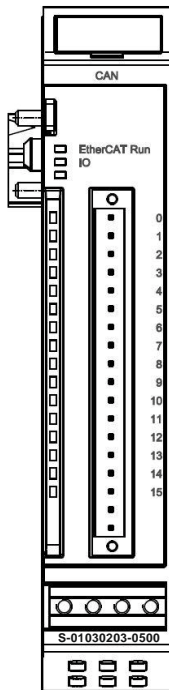

Figure 77: Front view of CAN I/O module

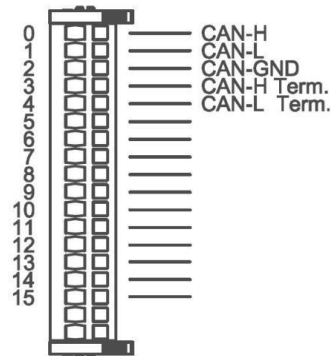

Figure 78: I/O connection

10.1.1. Terminals

CAN		
Pin	Signal	Explanation
0	CAN-H	CAN-High Signal
1	CAN-L	CAN-Low Signal
2	CAN-GND	Earth potential
3	CAN-H Terminal	Bus termination CAN-H
4	CAN-L Terminal	Bus termination CAN-L
5..15	-	Not used

10.1.2. Status LEDs

“EtherCAT” LED

The LED labeled “EtherCAT” indicates the state of the EtherCAT ASIC.

EtherCAT		
State	LED flash code	Explanation
Init	Red, off	Initializing, no data exchange
Pre-Op	Red/green, 1:1	Pre-operational, no data exchange
Safe-Op	Red/green, 5:1	Safe operation, inputs readable
Op	Green, on	Operational, unrestricted data exchange

“I/O” LED

The LED labeled “I/O” indicates the state of the module's I/Os.

I/O		
State	LED flash code	Explanation
Ok	Green, on	No error
Error	Red, 4x	EtherCAT watchdog
	Red, 5x	Transmit queue overflow
	Red, 6x	Receive queue overflow
	Red, 7x	No Tx counter

“Power” LED

There is no LED labeled “Power” because a separate power feed is not required.

LEDs Channel [COM State]

The LEDs labeled "Channel" indicate the state of every channel.

Channel	
LED colour, flash code	Explanation
Red, off	No communication
Green, flashing	Communication
Alternating red/green, flashing	CAN warning while communicating
Red, flashing	CAN warning
Red, on	CAN Bus Off

10.1.3. Function

The MC-I/O CAN module is a layer 2 EtherCAT CAN gateway. CODESYS provides the higher-layer protocols (CANopen Master / Slave, etc.). The module is based on the EtherCAT slave stack version 5.11. In CODESYS 3, the module provides a CANbus port that further configurations can be connected to. A device description available for CODESYS 3 contains all the required details. Mind that you also need the device driver (CAN Mini Driver).

All required data can be requested from our technical support or downloaded from our website.

Screen if the device description has been installed properly:

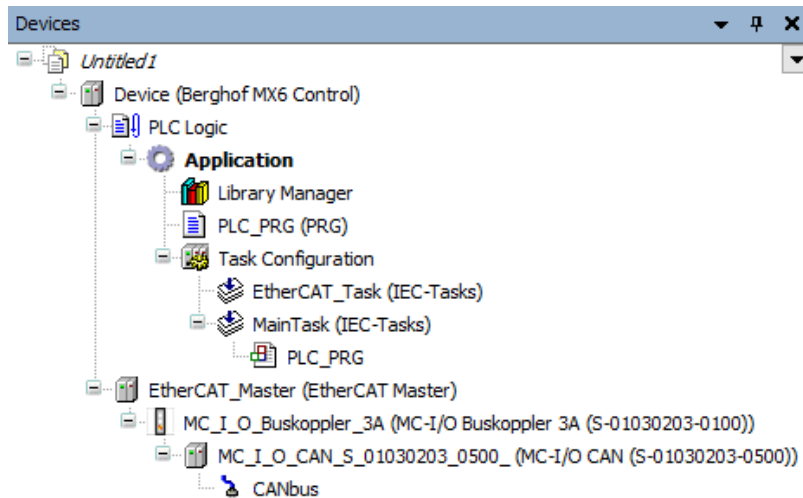

Figure 79: DeviceDescription

Process Image

There are 20 PDOs containing 8 bytes of data each for every direction. Use PDO Assignment (objects 1C12 and 1C13) to vary the volume of data. Taken together with the mailboxes (32 bytes each), this is the maximum configuration of ET1200.

Output Data (PLC -> IO, 0-160 Bytes)

Name	Size	Source
ControlData	8 bytes	PLC
TxData1[0..7]	8 bytes	PLC
...
TxData19[0..7]	8 bytes	PLC

The CAN data in this data range are superposed. The data range can hold up to 9 CAN messages. If so, Rx/TxData19 stays blank.

ControlData:

Name	Format	Source
TxCounter	Word	Incrementing the TxCounter tells the gateway that the process image contains new data to be sent.
RxCounterCon	Word	If synchronised data (RxSync) is used, this object is used to acknowledge that the data received has been processed. Only then will the gateway send the next data.
TxNrOfMsg	Word	Number of CAN messages in the process image. Range: 0..9.
ResetError	Bit (1)	Bit 0 ->1: Resets errors that have been removed.
unused 0..14	Bit (15)	

TxData1,2 / 3,4 / 5,6 / 7,8 / 9,10 / 11,12 / 13,14 / 15,16 / 17,18:

Byte	Name	Bedeutung
0	CanIdLowWordLowByte	CAN Identifier.
1	CanIdLowWordHighByte	ExtendedId = 0 -> 11 bit. ExtendedId = 1 -> 29 bit.
2	CanIdHighWordLowByte	
3	CanIdHighWordHighByte	
4	CanDataLength	Number of data bytes. Range: 0..8
5	RemoteFrame	RemoteFrame = 1 -> no data, just request to send the identifier
6	ExtendendId	ExtendedId = 0 -> 11 bit, ExtendedId = 1 -> 29 bit.
7	Reserved	-
8	Data[0]	Payload data.
9	Data[1]	Only "CanDataLength" bytes are sent.
10	Data[2]	
11	Data[3]	
12	Data[4]	
13	Data[5]	
14	Data[6]	
15	Data[7]	

Input Data (IO -> PLC, 0..160 bytes)

Name	Size	Source
StateData	8 bytes	IO
RxData1[0..7]	8 bytes	IO
...
RxData19[0..7]	8 bytes	IO

StateData:

Name	Format	Source
TxCounterCon	Word	The gateway shows the TxCounter again to confirm the new out-queue data.
RxCounter	Word	Incrementing the RxCounter indicates that the process image contains new in-queue data.
RxNrOfMsg	Word	Number of CAN messages in the process image. Range: 0..9.
ResetErrorAck	Bit (1)	Acknowledges the state of the Reset Error signal.
EtherCATErrror	Bit (1)	If 1: Sync Manager watchdog triggered (watchdog control)
CanTxQueueOvr	Bit (1)	Overflow of the gateway's out-buffer. Too much CAN data is being sent or CAN bus the baud rate is too low.
CanRxQueueOvr	Bit (1)	In-buffer overflow. CAN data is being accepted too slowly. Either speed up the EtherCAT task or reduce the bus load.
TxCounterMiss	Bit (1)	The gateway checks the TxCounter for steady increments. This error indicates a skipped increment. Best use TxCounterCon to send new data.
CanWarning	Bit (1)	Indicates the CAN controller states "CAN Warning" and "Error Passive". These states are retained unless several frames are sent and received without errors. Reset Error is NOT required to acknowledge the bit.
CanBusOff	Bit (1)	Massive problems have changed the CAN controller's state to "bus off". The controller will quit this error state automatically.
unused 0..5	Bit (6)	
CanTxBusy	Bit (1)	1: Data is being sent.
unused 6..7	Bit (2)	

RxData1,2 / 3,4 / 5,6 / 7,8 / 9,10 / 11,12 / 13,14 / 15,16 / 17,18:

Byte	Name	Explanation
0	CanIdLowWordLowByte	CAN Identifier.
1	CanIdLowWordHighByte	ExtendedId = 0 -> 11 bit. ExtendedId = 1 -> 29 bit.
2	CanIdHighWordLowByte	
3	CanIdHighWordHighByte	
4	CanDataLength	Number of data bytes. Range: 0..8
5	RemoteFrame	RemoteFrame = 1 -> no data, just request to send the identifier
6	ExtendedId	ExtendedId = 0 -> 11 bit, ExtendedId = 1 -> 29 bit.
7	Reserved	-
8	Data[0]	Payload data.
9	Data[1]	Only the number of bytes in "CanDataLength" is accepted.
10	Data[2]	
11	Data[3]	
12	Data[4]	
13	Data[5]	
14	Data[6]	
15	Data[7]	

Configuration

To set the baud rate, go down the device tree and find the CAN node immediately underneath the B-Nimis MC-I/O CAN module.

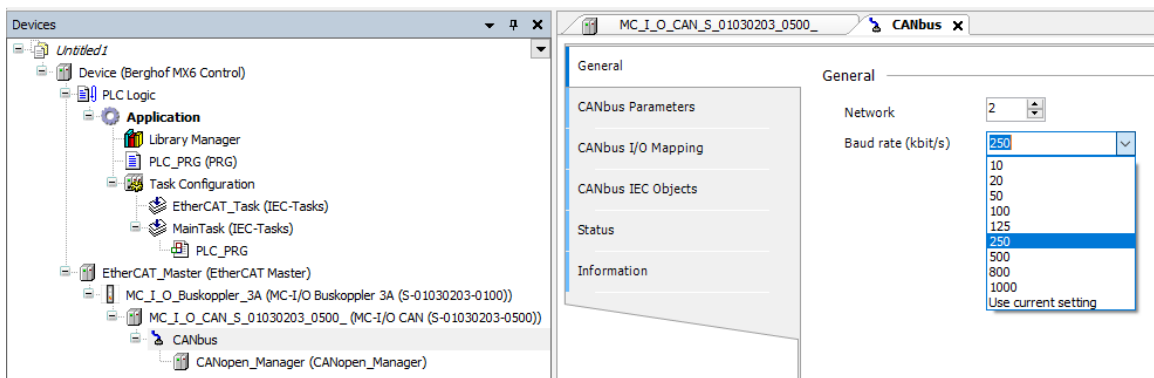

Figure 80: Baud rate setting

i NOTE

Information:

The B-Nimis MC-I/O CAN module does NOT support all CODESYS baud rates (refer to the object dictionary).

The following baud rates are supported:

→ 100, 125, 250, 500 and 1000 kBit/s

Go to the startup parameters of the CAN module to enable or disable data synchronisation. Select the module and go to "Startup parameters" and "+ Add".

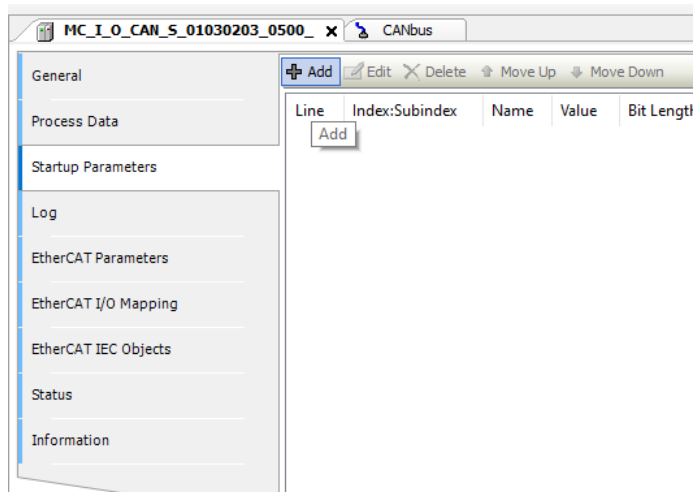

Figure 81: Startup Parameters: add

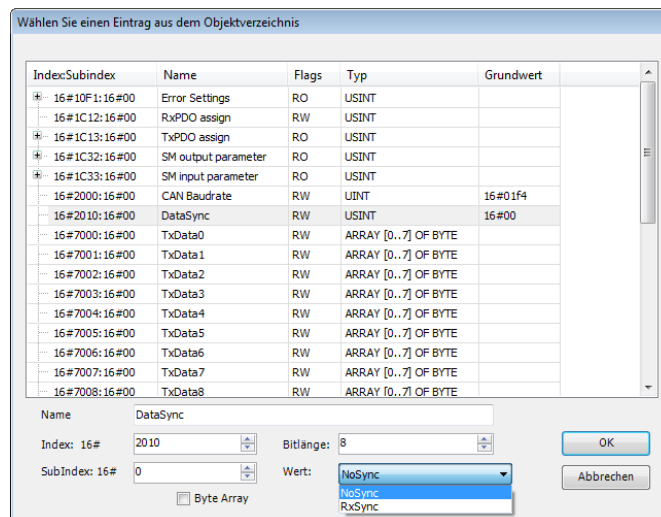

Figure 82: Enable or disable data synchronisation

Your settings are then displayed on tab "Startup Parameters".

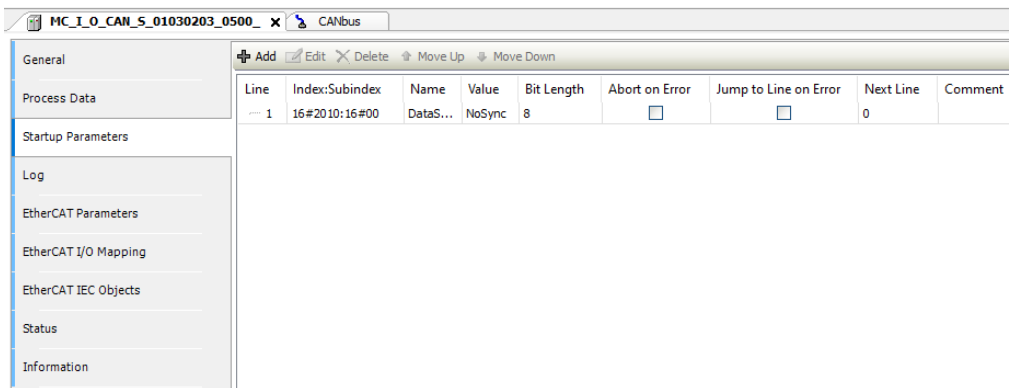

Figure 83: "Startup Parameters" with selected settings

Response to Errors

- EtherCAT error.
Sync Manager watchdog.
LED "Error" flashes 4x.
Unit changes from Op to Safe-Op.
Use "Reset Error" to acknowledge the error.
- Out-queue overflow (CanTxQueueOvr).
Failure to send the data fast enough across the CAN bus.
LED "Error" flashes 5x.
Use "Reset Error" to acknowledge the error.
- In-queue overflow (CanRxQueueOvr).
Too much data is being received via the CAN bus. and cannot be transferred to the control unit fast enough.
LED "Error" flashes 6x.
Use "Reset Error" to acknowledge the error.
- TxCount error (TxCounterMiss).
The TxCounter received is not "last TxCounter + 1".
The gateway probably missed an EtherCAT frame. The EtherCAT master is sending the data too quickly (< 1ms for 9 messages).
LED "Error" flashes 7x.
Use "Reset Error" to acknowledge the error.
- CAN warning.
Indicates the CAN controller states "CAN Warning" and "Error Passive". These states are retained unless several frames are sent and received without errors.
LED "CAN" is red and flashes rapidly (or alternates between green and red while communicating).
"Reset Error" is NOT required to acknowledge the error.
- CAN Bus Off.
Massive problems have changed the CAN controller's state to "bus off". The controller will quit this error state automatically.
LED "CAN" lights up red.
Use "Reset Error" to acknowledge the error.

Object dictionary

Index	Name	Type	Default	Min Max	Access
1000	Device Typ	UINT32	0x191		RO
1001	Error Register	UINT8			RO
1008	Device Name	String	FIO CAN		RO
1009	Hardware Version	String	1.00		RO
100A	Software Version	String	1.00		RO
1018	Identity Object	Array			
1018, 0	Number of Entries	UINT8	4		RO
1018, 1	Vendor Id	UINT32	0x0048554B		RO
1018, 2	Product Code	UINT32	185580		RO
1018, 3	Revision Number	UINT32	1		RO
1018, 4	Serial Number	UINT32	0		RO
10F1,0	Number of Entries	UINT8	2		RO
10F1,1	Local Error Reaction	UINT32	1		RW
10F1,2	Sync Error Counter Limit	UINT32	4		RW
1600	Receive PDO0 Mapping Parameter	Array			
1600, 0	Number of Entries	UINT8	5		RO
1600, 1	SubIndex 001	UINT32	0x71000010		RO
1600, 2	SubIndex 002	UINT32	0x71010010		RO
1600, 3	SubIndex 003	UINT32	0x71020010		RO
1600, 4	SubIndex 004	UINT32	0x71100101		RO
1600, 5	SubIndex 005	UINT32	0x0000000F		RO
1601	ReceivePDO1 Mapping Parameter	Array			
1601, 0	Number of Entries	UINT8	1		RO
1601, 1	SubIndex 001	UINT32	0x70010040		RO
1602	ReceivePDO2 Mapping Parameter	Array			
1602, 0	Number of Entries	UINT8	1		RO
1602, 1	SubIndex 001	UINT32	0x70020040		RO
1603	ReceivePDO3 Mapping Parameter	Array			
1603, 0	Number of Entries	UINT8	1		RO
1603, 1	SubIndex 001	UINT32	0x70030040		RO
1604	ReceivePDO4 Mapping Parameter	Array			
1604, 0	Number of Entries	UINT8	1		RO
1604, 1	SubIndex 001	UINT32	0x70040040		RO
1605	ReceivePDO5 Mapping Parameter	Array			
1605, 0	Number of Entries	UINT8	1		RO
1605, 1	SubIndex 001	UINT32	0x70050040		RO
1606	ReceivePDO6 Mapping Parameter	Array			

Index	Name	Type	Default	Min Max	Access
1606, 0	Number of Entries	UINT8	1		RO
1606, 1	SubIndex 001	UINT32	0x70060040		RO
1607	ReceivePDO7 Mapping Parameter	Array			
1607, 0	Number of Entries	UINT8	1		RO
1607, 1	SubIndex 001	UINT32	0x70070040		RO
1608	ReceivePDO8 Mapping Parameter	Array			
1608, 0	Number of Entries	UINT8	1		RO
1608, 1	SubIndex 001	UINT32	0x70080040		RO
1609	ReceivePDO9 Mapping Parameter	Array			
1609, 0	Number of Entries	UINT8	1		RO
1609, 1	SubIndex 001	UINT32	0x70090040		RO
160A	ReceivePDO10 Mapping Parameter	Array			
160A, 0	Number of Entries	UINT8	1		RO
160A, 1	SubIndex 001	UINT32	0x700A0040		RO
160B	ReceivePDO11 Mapping Parameter	Array			
160B, 0	Number of Entries	UINT8	1		RO
160B, 1	SubIndex 001	UINT32	0x700B0040		RO
160C	ReceivePDO12 Mapping Parameter	Array			
160C, 0	Number of Entries	UINT8	1		RO
160C, 1	SubIndex 001	UINT32	0x700C0040		RO
160D	ReceivePDO13 Mapping Parameter	Array			
160D, 0	Number of Entries	UINT8	1		RO
160D, 1	SubIndex 001	UINT32	0x700D0040		RO
160E	ReceivePDO14 Mapping Parameter	Array			
160E, 0	Number of Entries	UINT8	1		RO
160E, 1	SubIndex 001	UINT32	0x700E0040		RO
160F	ReceivePDO15 Mapping Parameter	Array			
160F, 0	Number of Entries	UINT8	1		RO
160F, 1	SubIndex 001	UINT32	0x700F0040		RO
1610	ReceivePDO16 Mapping Parameter	Array			
1610, 0	Number of Entries	UINT8	1		RO
1610, 1	SubIndex 001	UINT32	0x70100040		RO
1611	ReceivePDO17 Mapping Parameter	Array			
1611, 0	Number of Entries	UINT8	1		RO
1611, 1	SubIndex 001	UINT32	0x70110040		RO

Index	Name	Type	Default	Min Max	Access
1612	ReceivePDO18 Mapping Parameter	Array			
1612, 0	Number of Entries	UINT8	1		RO
1612, 1	SubIndex 001	UINT32	0x70120040		RO
1613	ReceivePDO19 Mapping Parameter	Array			
1613, 0	Number of Entries	UINT8	1		RO
1613, 1	SubIndex 001	UINT32	0x70130040		RO
1A00	Transmit PDO0 Mapping Parameter	Array			
1A00, 0	Number of Entries	UINT8	13		RO
1A00, 1	SubIndex 001	UINT32	0x66000010		RO
1A00, 2	SubIndex 002	UINT32	0x66010010		RO
1A00, 3	SubIndex 003	UINT32	0x66020010		RO
1A00, 4	SubIndex 004	UINT32	0x65010101		RO
1A00, 5	SubIndex 005	UINT32	0x65010201		RO
1A00, 6	SubIndex 006	UINT32	0x65010301		RO
1A00, 7	SubIndex 007	UINT32	0x65010401		RO
1A00, 8	SubIndex 008	UINT32	0x65010501		RO
1A00, 9	SubIndex 009	UINT32	0x65010601		RO
1A00, 10	SubIndex 010	UINT32	0x65010701		RO
1A00, 11	SubIndex 011	UINT32	0x00000006		RO
1A00, 12	SubIndex 012	UINT32	0x65010E01		RO
1A00, 13	SubIndex 013	UINT32	0x00000002		RO
1A01	Transmit PDO1 Mapping Parameter	Array			
1A01, 0	Number of Entries	UINT8	1		RO
1A01, 1	SubIndex 001	UINT32	0x75010040		RO
1A02	Transmit PDO2 Mapping Parameter	Array			
1A02, 0	Number of Entries	UINT8	1		RO
1A02, 1	SubIndex 001	UINT32	0x75020040		RO
1A03	Transmit PDO3 Mapping Parameter	Array			
1A03, 0	Number of Entries	UINT8	1		RO
1A03, 1	SubIndex 001	UINT32	0x75030040		RO
1A04	Transmit PDO4 Mapping Parameter	Array			
1A04, 0	Number of Entries	UINT8	1		RO
1A04, 1	SubIndex 001	UINT32	0x75040040		RO
1A05	Transmit PDO5 Mapping Parameter	Array			
1A05, 0	Number of Entries	UINT8	1		RO
1A05, 1	SubIndex 001	UINT32	0x75050040		RO
1A06	Transmit PDO6 Mapping Parameter	Array			
1A06, 0	Number of Entries	UINT8	1		RO

Index	Name	Type	Default	Min Max	Access
1A06, 1	SubIndex 001	UINT32	0x75060040		RO
1A07	Transmit PDO7 Mapping Parameter	Array			
1A07, 0	Number of Entries	UINT8	1		RO
1A07, 1	SubIndex 001	UINT32	0x75070040		RO
1A08	Transmit PDO8 Mapping Parameter	Array			
1A08, 0	Number of Entries	UINT8	1		RO
1A08, 1	SubIndex 001	UINT32	0x75080040		RO
1A09	Transmit PDO9 Mapping Parameter	Array			
1A09, 0	Number of Entries	UINT8	1		RO
1A09, 1	SubIndex 001	UINT32	0x75090040		RO
1A0A	Transmit PDO10 Mapping Parameter	Array			
1A0A, 0	Number of Entries	UINT8	1		RO
1A0A, 1	SubIndex 001	UINT32	0x750A0040		RO
1A0B	Transmit PDO11 Mapping Parameter	Array			
1A0B, 0	Number of Entries	UINT8	1		RO
1A0B, 1	SubIndex 001	UINT32	0x750B0040		RO
1A0C	Transmit PDO12 Mapping Parameter	Array			
1A0C, 0	Number of Entries	UINT8	1		RO
1A0C, 1	SubIndex 001	UINT32	0x750C0040		RO
1A0D	Transmit PDO13 Mapping Parameter	Array			
1A0D, 0	Number of Entries	UINT8	1		RO
1A0D, 1	SubIndex 001	UINT32	0x750D0040		RO
1A0E	Transmit PDO14 Mapping Parameter	Array			
1A0E, 0	Number of Entries	UINT8	1		RO
1A0E, 1	SubIndex 001	UINT32	0x750E0040		RO
1A0F	Transmit PDO15 Mapping Parameter	Array			
1A0F, 0	Number of Entries	UINT8	1		RO
1A0F, 1	SubIndex 001	UINT32	0x750F0040		RO
1A10	Transmit PDO16 Mapping Parameter	Array			
1A10, 0	Number of Entries	UINT8	1		RO
1A10, 1	SubIndex 001	UINT32	0x75100040		RO
1A11	Transmit PDO17 Mapping Parameter	Array			
1A11, 0	Number of Entries	UINT8	1		RO
1A11, 1	SubIndex 001	UINT32	0x75110040		RO
1A12	Transmit PDO18 Mapping Parameter	Array			

Index	Name	Type	Default	Min Max	Access
1A12, 0	Number of Entries	UINT8	1		RO
1A12, 1	SubIndex 001	UINT32	0x75120040		RO
1A13	Transmit PDO19 Mapping Parameter	Array			
1A13, 0	Number of Entries	UINT8	1		RO
1A13, 1	SubIndex 001	UINT32	0x75130040		RO
1C00	Sync Manager Type	Array			
1C00, 0	Number of Entries	UINT8	4		RO
1C00, 1	SubIndex 001	UINT8	1		RO
1C00, 2	SubIndex 002	UINT8	2		RO
1C00, 3	SubIndex 003	UINT8	3		RO
1C00, 4	SubIndex 004	UINT8	4		RO
1C12	RxPDO assign	Array			
1C12, 0	Number of Entries	UINT8	20		RW
1C12, 1	SubIndex 001	UINT16	0x1600		RW
1C12, 2	SubIndex 002	UINT16	0x1601		RW
1C12, 3	SubIndex 003	UINT16	0x1602		RW
1C12, 4	SubIndex 004	UINT16	0x1603		RW
1C12, 5	SubIndex 005	UINT16	0x1604		RW
1C12, 6	SubIndex 006	UINT16	0x1605		RW
1C12, 7	SubIndex 007	UINT16	0x1606		RW
1C12, 8	SubIndex 008	UINT16	0x1607		RW
1C12, 9	SubIndex 009	UINT16	0x1608		RW
1C12, 10	SubIndex 010	UINT16	0x1609		RW
1C12, 11	SubIndex 011	UINT16	0x160A		RW
1C12, 12	SubIndex 012	UINT16	0x160B		RW
1C12, 13	SubIndex 013	UINT16	0x160C		RW
1C12, 14	SubIndex 014	UINT16	0x160D		RW
1C12, 15	SubIndex 015	UINT16	0x160E		RW
1C12, 16	SubIndex 016	UINT16	0x160F		RW
1C12, 17	SubIndex 017	UINT16	0x1610		RW
1C12, 18	SubIndex 018	UINT16	0x1611		RW
1C12, 19	SubIndex 019	UINT16	0x1612		RW
1C12, 20	SubIndex 020	UINT16	0x1613		RW
1C13	TxPDO assign	Array			
1C13, 0	Number of Entries	UINT8	20		RO
1C13, 1	SubIndex 001	UINT16	0x1A00		RO
1C13, 2	SubIndex 002	UINT16	0x1A01		RO
1C13, 3	SubIndex 003	UINT16	0x1A02		RO
1C13, 4	SubIndex 004	UINT16	0x1A03		RO
1C13, 5	SubIndex 005	UINT16	0x1A04		RO
1C13, 6	SubIndex 006	UINT16	0x1A05		RO
1C13, 7	SubIndex 007	UINT16	0x1A06		RO
1C13, 8	SubIndex 008	UINT16	0x1A07		RO
1C13, 9	SubIndex 009	UINT16	0x1A08		RO

Index	Name	Type	Default	Min Max	Access
1C13, 10	SubIndex 010	UINT16	0x1A09		RO
1C13, 11	SubIndex 011	UINT16	0x1A0A		RO
1C13, 12	SubIndex 012	UINT16	0x1A0B		RO
1C13, 13	SubIndex 013	UINT16	0x1A0C		RO
1C13, 14	SubIndex 014	UINT16	0x1A0D		RO
1C13, 15	SubIndex 015	UINT16	0x1A0E		RO
1C13, 16	SubIndex 016	UINT16	0x1A0F		RO
1C13, 17	SubIndex 017	UINT16	0x1A10		RO
1C13, 18	SubIndex 018	UINT16	0x1A11		RO
1C13, 19	SubIndex 019	UINT16	0x1A12		RO
1C13, 20	SubIndex 020	UINT16	0x1A13		RO
1C32	SM output parameter	Record			
1C32, 0	Number of Entries	UINT8	32		RO
1C32, 1	Synchronisation Type	UINT16	0x0001		RW
1C32, 2	Cycle Time	UINT32			RO
1C32, 4	Synchronisation Types supported	UINT16	0x8007		RO
1C32, 5	Minimum Cycle Time	UINT32			RO
1C32, 6	Calc and Copy Time	UINT32			RO
1C32, 8	Get Cycle Time	UINT16			RW
1C32, 9	Delay Time	UINT32			RO
1C32, 10	Sync0 Cycle Time	UINT32			RW
1C32, 11	SM-Event Missed	UINT16			RO
1C32, 12	Cycle Time too small	UINT16			RO
1C32, 32	Sync Error	BOOL			RO
1C33	SM input parameter	Record			
1C33, 0	Number of Entries	UINT8	32		RO
1C33, 1	Synchronisation Type	UINT16	0x0022		RW
1C33, 2	Cycle Time	UINT32			RO
1C33, 4	Synchronisation Types supported	UINT16	0x8007		RO
1C33, 5	Minimum Cycle Time	UINT32			RO
1C33, 6	Calc and Copy Time	UINT32			RO
1C33, 8	Get Cycle Time	UINT16			RW
1C33, 9	Delay Time	UINT32			RO
1C33, 10	Sync0 Cycle Time	UINT32			RW
1C33, 11	SM-Event Missed	UINT16			RO
1C33, 12	Cycle Time too small	UINT16			RO
1C33, 32	Sync Error	BOOL			RO
2000	CAN Baudrate	UINT32	500	100 125 250 500 1000	RW
2010	DataSync	UINT8	NoSync	NoSync (0) RxSync (1)	RW

Index	Name	Type	Default	Min Max	Access
6500	StateWord	Array			
6500, 0	Number of Entries	UINT8	16		RO
6500, 1	ResetErrorAck	BOOL			RO P
6500, 2	EtherCAT Error	BOOL			RO P
6500, 3	CanTxQueueOvr	BOOL			RO P
6500, 4	CanRxQueueOvr	BOOL			RO P
6500, 5	TxCounterMiss	BOOL			RO P
6500, 6	CanWarning	BOOL			RO P
6500, 7	CanBusOff	BOOL			RO P
6500, 8	unused0	BOOL			RO P
6500, 9	unused1	BOOL			RO P
6500, 10	unused2	BOOL			RO P
6500, 11	unused3	BOOL			RO P
6500, 12	unused4	BOOL			RO P
6500, 13	unused5	BOOL			RO P
6500, 14	CanTxBusy	BOOL			RO P
6500, 15	unused6	BOOL			RO P
6500, 16	unused7	BOOL			RO P
6600	TxCounterCon	UINT16		0..65535	RO P
6601	RxCounter	UINT16		0..65535	
6602	RxNrOfMsg	UINT16		0..9	
7000	TxData0	UINT64	0		RW P
7001	TxData1	UINT64	0		RW P
7002	TxData2	UINT64	0		RW P
7003	TxData3	UINT64	0		RW P
7004	TxData4	UINT64	0		RW P
7005	TxData5	UINT64	0		RW P
7006	TxData6	UINT64	0		RW P
7007	TxData7	UINT64	0		RW P
7008	TxData8	UINT64	0		RW P
7009	TxData9	UINT64	0		RW P
700A	TxData10	UINT64	0		RW P
700B	TxData11	UINT64	0		RW P
700C	TxData12	UINT64	0		RW P
700D	TxData13	UINT64	0		RW P
700E	TxData14	UINT64	0		RW P
700F	TxData15	UINT64	0		RW P
7010	TxData16	UINT64	0		RW P
7011	TxData17	UINT64	0		RW P
7012	TxData18	UINT64	0		RW P
7013	TxData19	UINT64	0		RW P
7100	TxCounter	UINT16		0..65535	RW P
7101	RxCounterCon	UINT16		0..65535	RW P
7102	TxNrOfMsg	UINT16		0..9	RW P
7110	ControlWord	Array			

Index	Name	Type	Default	Min Max	Access
7110, 0	Number of Entries	UINT8	16		RO
7110, 1	ResetError	BOOL			RW P
7110, 2	unused0	BOOL			RW P
7110, 3	unused1	BOOL			RW P
7110, 4	unused2	BOOL			RW P
7110, 5	unused3	BOOL			RW P
7110, 6	unused4	BOOL			RW P
7110, 7	unused5	BOOL			RW P
7110, 8	unused6	BOOL			RW P
7110, 9	unused7	BOOL			RW P
7110, 10	unused8	BOOL			RW P
7110, 11	unused9	BOOL			RW P
7110, 12	unused10	BOOL			RW P
7110, 13	unused11	BOOL			RW P
7110, 14	unused12	BOOL			RW P
7110, 15	unused13	BOOL			RW P
7110, 16	unused14	BOOL			RW P
7500	RxData0	UINT64			RO P
7501	RxData1	UINT64			RO P
7502	RxData2	UINT64			RO P
7503	RxData3	UINT64			RO P
7504	RxData4	UINT64			RO P
7505	RxData5	UINT64			RO P
7506	RxData6	UINT64			RO P
7507	RxData7	UINT64			RO P
7508	RxData8	UINT64			RO P
7509	RxData9	UINT64			RO P
750A	RxData10	UINT64			RO P
750B	RxData11	UINT64			RO P
750C	RxData12	UINT64			RO P
750D	RxData13	UINT64			RO P
750E	RxData14	UINT64			RO P
750F	RxData15	UINT64			RO P
7510	RxData16	UINT64			RO P
7511	RxData17	UINT64			RO P
7512	RxData18	UINT64			RO P
7513	RxData19	UINT64			RO P

RO=read-only, RW= read/write, P=process image

10.1.4. Technical data

CAN	
Label	MC-I/O CAN
Part no.	S-01030203-0500
Plug-in connector	18-pole, S-02020201-0800 (not part of the module)
Interface	CAN, electrically insulated
Baud rate	100,125, 250, 500 und 1000 kbit/s
Payload data	9 frames of max. 8 bytes In/Out per EtherCAT cycle
Controller	ASIC ET1200
E-bus connector	10-pole system plug in side wall
Term. module	not required
Power supply	via E-bus
E-bus load	max.330 mA
UL approval	

11. EXTENDER

11.1. EXTENDER 2 PORT

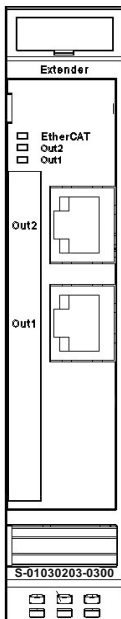

Figure 84: MC-I/O EXTENDER 2 PORT

The purpose of the B-Nimis MC-I/O EXTENDER is the extension of a B-Nimis MC-I/O block or an EC1000 by EtherCAT slaves, which have a standard 100 base TX connection.

The EXTENDER module changes the transmitting physics of LVDS (E-bus) on twisted pair. The module is usually arranged thereby at the end of the block.

In addition, the EXTENDER can be used in arbitrary place behind the bus coupler and/or the EC1000 PLC controller. Thus EtherCAT slaves can also be connected in star topology.

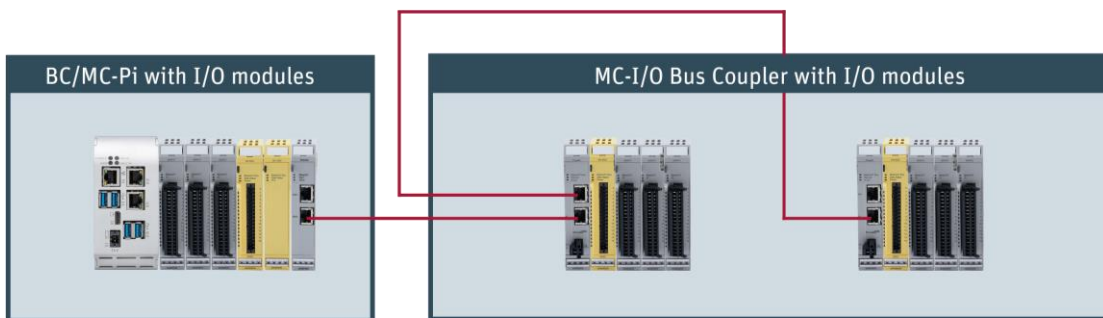

Figure 85: Overview extensions

11.1.1. Terminals

Supply of the module
via E-bus

EtherCAT (RJ45 socket)

OUT1: Output port (to the next EtherCAT device)

OUT2: Output port (to the next EtherCAT device)

11.1.2. Status LEDs

“EtherCAT” LED

The LED labeled “EtherCAT” indicates the state of the EtherCAT ASIC.

EtherCAT		
State	LED flash code	Explanation
Init	Red, on	Initializing, no data exchange
Pre-Op	Red/green, 1:1	Pre-operational, no data exchange
Safe-Op	Red/green, 5:1	Safe operation, inputs readable
Op	Green, on	Operational, unrestricted data exchange

“Out2” LED/“Out1” LED

The “Out2” LED and the “Out1” LED indicate the physical state of the Ethernet port they are allocated to.

Out2 / Out1		
State	LED flash code	Explanation
Not connected	Off	No Ethernet connection
Connected	Green, on	Connected to Ethernet
Traffic	Green, flashing light	Exchanging telegrams

11.1.3. Function

The EXTENDER 2 PORT module has actually 4 ports. Name 2 PORT module was chosen because of the 2 standard 100 base TX (OUT1, OUT2) RJ45 connections. Another 2 ports are covered by the E-bus.

It is important to the configuration in which sequence the connections are operated, i.e. which way the EtherCAT frame runs.

Function		
Port	Connection	Sequence
Port A	E-Bus In	1
Port B	Out 1	3
Port C	Out 2	4
Port D	E-Bus Out	2

11.1.4. Technical data

EXTENDER 2 PORT	
Label	MC-I/O EXTENDER 2 PORT
Part no.	S-01030203-0300
Function	Extension of a B-Nimis MC-I/O block resp. of an EC1000 Transformation of transmission physics from LVDS (E-bus) to 100Base-TX
Controller	ASIC ET1100
Baud rate	100 Mbit/s
Cable	CAT5
Cable length	max. 100 m
EtherCAT Connection	2 x RJ45
Power supply	via E-bus
E-bus load	160 mA for Out1 / 210 mA for Out1 + Out2
UL approval	 <p>UL LISTED 59DM E242595 IND.CONT.EQ.</p>

12. Supplement

12.1. POTENTIALVERTEILER 2x16 (Potential distributor)

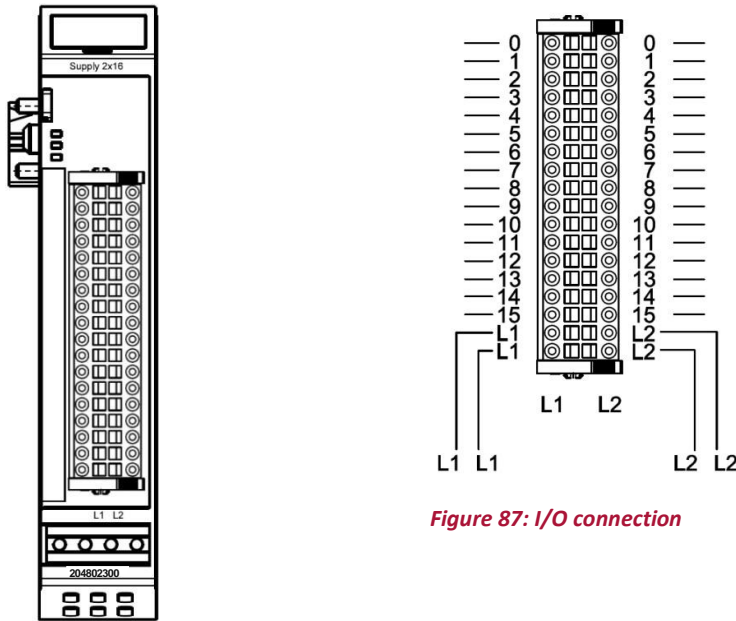

Figure 86: Front view of POTENTIALVERTEILER 2x16

Figure 87: I/O connection

12.1.1. Terminals

The module POTENTIALVERTEILER 2x16 has 2 separate potential lines.

It distributes the potential (optional 0 V DC or 24 V DC) attached at the pins L1 or L2 on the pins 0 to 15 of the same row.

The E-bus is passed on from the previous one to the next module.

12.1.2. Status LEDs

The module has no status LEDs.

12.1.3. Function

2-wire or 3-wire terminals for digital I/O modules

12.1.4. Technical data

Potential distributor	
Label	POTENTIALVERTEILER 2x16
Part no.	204802300
Plug-in connector	36-pole S-02020201-0900 (not part of the module)
E-bus port	10-pin system plug in side wall
E-bus load	none
UL approval	

12.2. SHIELD CONNECTION CLAMP (Shield connection terminal block)

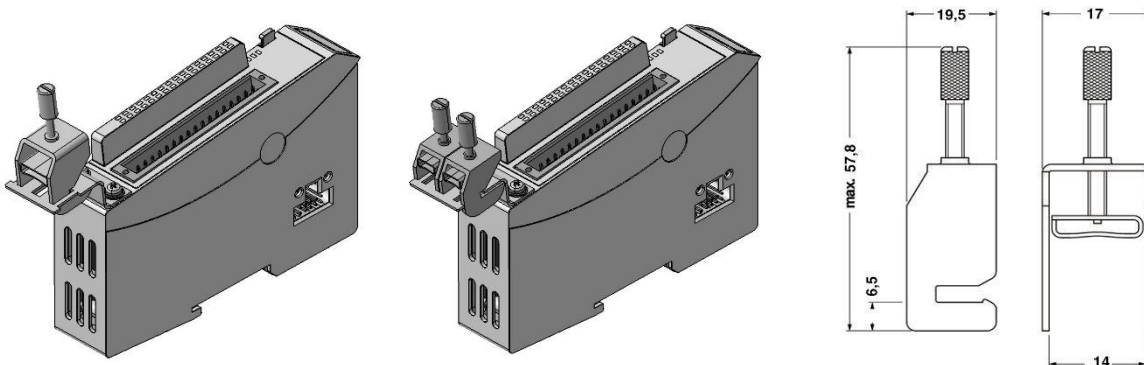

SHIELD CONNECTION CLAMP 1x14 mm;

2x8 mm

Dimensions of the 14 mm terminal

12.2.1. Terminals

The shield connection terminal block consists of the shield clamp, the clamp holder, 2 screws M3x5, 2 washers and 2 spring washers. Fasten the clamp holder with the 2 screws by using the washers and spring washers on the housing of the B-Nimis MC-I/O module. Use the two tapped holes on the front side below. They are provided for it.



Figure 88: SHIELD CONNECTION CLAMP 14 mm

12.2.2. Function

The shield connection terminal block makes it easy to apply the cable shield. The shield connection terminal block conducts the potential of the cable screen on the DIN top hat rail on which the B-Nimis MC-I/O module is picked up.

WARNING

The mounting rail must have a suitable earth connection.

The shield connection terminal blocks may not be used as strain relief. See also section 3.1.1 Earth.

12.2.3. Technical data

Shield connection terminal block

Label	SCHIRMANSCHLUSSKLEMME 2x8 mm
Part no.	204802400

13. Annex

13.1. Environmental Protection

13.1.1. Emission

When used correctly, our modules do not produce any harmful emissions.

13.1.2. Disposal

At the end of their service life, modules may be returned to the manufacturer against payment of an all-inclusive charge to cover costs. The manufacturer will then arrange for the modules to be recycled.

13.2. Maintenance/Upkeep

WARNING

Do not insert, apply, detach or touch connections while in operation – risk of destruction or malfunction.

Disconnect all incoming power supplies before working on our modules; this also applies to connected peripheral equipment such as externally powered sensors, programming devices, etc. All ventilation openings must always be kept free of any obstruction.

- The modules are maintenance-free when used correctly.
- Clean only with a dry, non-fluffing cloth.
- Do not use detergents!

13.3. Repairs/Service

WARNING

Repair work may only be carried out by the manufacturer or its authorised service engineers.

13.3.1. Warranty

Sold under statutory warranty conditions. Warranty lapses in the event of unauthorised attempts to repair the equipment and/or product, or in the event of any other form of intervention.

13.4. Product identification

The product identification is on the front part and on the side part.

Product identification descriptions (example)

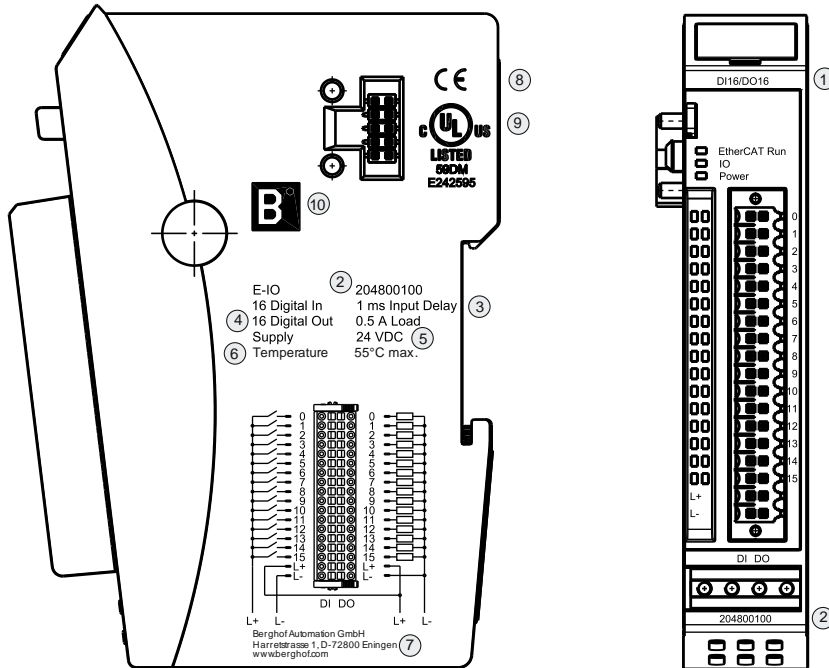

Figure 89: Product identification

- ① Designation of device type
- ② Item no.
- ③ Input delay
- ④ Max. current
- ⑤ Power supply
- ⑥ Temperature
- ⑦ Manufacturer's address
- ⑧ CE marking
- ⑨ UL approval
- ⑩ Brand of the manufacturer (trademark)

2VF100670DG00.cdr

13.5. Addresses and Bibliography / Standards

13.5.1. Addresses

CAN in Automation; international manufacturers and users organisation for CAN users in the field of automation:

CAN in Automation e.V. (CiA)
Am Weichselgarten 26
D-91058 Erlangen / Germany
headquarters@can-cia.de
www.can-cia.de

EtherCAT Technology Group
ETG Headquarters
Ostendstraße 196
D-90482 Nürnberg / Germany
info@ethercat.org
www.ethercat.org

Beuth Verlag GmbH, 10772 Berlin

or

VDE-Verlag GmbH, 10625 Berlin

VDE Verlag GmbH, 10625 Berlin

or

Internet search: www.iec.ch

13.5.2. Bibliography / Standards

Standard	Label
IEC61131-1 / EN61131-1	Programmable controllers Part 1: General information
IEC61131-2 / EN61131-2	Programmable controllers Part 2: Equipment requirements and tests
IEC61131-3 / EN61131-3	Programmable controllers Part 3: Programming languages
IEC61131-4 / EN61131BI1	Programmable logic controllers Supplementary Sheet 1: User guidelines
IEC61000-6-4 / EN61000-6-4	German EMC Standard: Emitted interference
IEC61000-6-2 / EN61000-6-2	German EMC Standard: Noise immunity
ISO/DIS 11898	Draft International Standard: Road vehicles - Interchange of digital information - Controller Area Network (CAN) for high-speed communication
DIN EN ISO 13849-1	Safety of machinery: Safety-related parts of control systems (Part 1)
UL 508:2013-10	Industrial Control Equipment 17th Edition / 1999-01-28

Notice: Our Technical Support team will be glad to provide other literature references on request.

13.6. List of figures

Figure 1: Overview of variants	15
Figure 2: Mechanical design	18
Figure 3: Earth.....	19
Figure 4: Installation position	20
Figure 5: Rail mounting of module	21
Figure 6: Uninstalling a module.....	21
Figure 7: Bus coupler front view.....	26
Figure 8: Front view of.....	29
Figure 9: I/O connection	29
Figure 10: Front view of DI16/DO16 I/O module.....	33
Figure 11: I/O connection	33
Figure 12: Front view of DI32 I/O module	36
Figure 13: I/O connection	36
Figure 14: Front view of DI16 I/O module	38
Figure 15: I/O connection	38
Figure 16: Front view of DO16 I/O module	40
Figure 17: I/O connection	40
Figure 18: Front view of DO8 RELAIS NO 24V I/O module.....	43
Figure 19: I/O connection	43
Figure 20: Front view of DO8 RELAIS NO 230VAC I/O module	46
Figure 21: I/O connection.....	46
Figure 22: Front view of AI4-I I/O module	49
Figure 23: I/O connection passive/active power source	49
Figure 24: Front view of AI8-I I/O module	56
Figure 25: I/O connection passive/active power source	56
Figure 26: Measuring values	58
Figure 27: Front view of AI4-I 12BIT CoE I/O module	64
Figure 28: I/O connection	64
Figure 29: Values	66
Figure 30: Module options.....	67
Figure 31: Process data	67
Figure 32: Object dictionary	68
Figure 33: Front view of AI8-I 12BIT CoE I/O module	73
Figure 34: I/O connection	73
Figure 35: Measured values.....	75
Figure 36: Module options.....	76

Figure 37: Process data	76
Figure 38: Object dictionary.....	77
Figure 39: Front view of AI4/8-U I/O module.....	82
Figure 40: I/O connection	82
Figure 41: Front view of AI4/8-U 13BIT CoE I/O module	88
Figure 42: I/O connection	88
Figure 43: Module options	91
Figure 44: Process data	91
Figure 45: Object dictionary.....	92
Figure 46: Front view of AI8/16-U 13BIT CoE I/O module	97
Figure 47: I/O connection	97
Figure 48: Module options	100
Figure 49: Process data	100
Figure 50: Object dictionary.....	101
Figure 51: Front view of AO4-U/I I/O module	107
Figure 52: I/O connection	107
Figure 53: Front view of AO4-U/I.....	113
Figure 54: I/O connection	113
Figure 55: Module options	116
Figure 56: Process data	116
Figure 57: Start parameter	117
Figure 58: Click/tap on "Add	117
Figure 59: Front view of AI4-PT/NI100 I/O module	122
Figure 60: I/O connection	122
Figure 61: Front view of AI8-PT/NI100 I/O module	129
Figure 62: I/O connection	129
Figure 63: Front view of AI4-THERMO I/O module.....	135
Figure 64: I/O connection	135
Figure 65: Front view of AI4-PT/NI/THERMO 16BIT CoE I/O module.....	140
Figure 66: I/O connection	140
Figure 67: Module options	142
Figure 68: Process data	142
Figure 69: Object dictionary.....	143
Figure 70: Front view of AI8-PT/NI/THERMO 16BIT CoE I/O module.....	151
Figure 71: I/O connection	151
Figure 72: Module options	153
Figure 73: Process data	153
Figure 74: Object dictionary.....	154

Figure 75: Front view of COUNTER/POS12 5V I/O module..... 165

Figure 76: I/O connection 165

Figure 77: Front view of CAN I/O module 184

Figure 78: I/O connection 184

Figure 79: DeviceDescription 186

Figure 80: Baud rate setting 189

Figure 81: Startup Parameters: add..... 190

Figure 82: Enable or disable data synchronisation 190

Figure 83: “Startup Parameters” with selected settings 191

Figure 84: MC-I/O EXTENDER 2 PORT 201

Figure 85: Overview extensions 201

Figure 86: Front view of POTENTIALVERTEILER 2x16 204

Figure 87: I/O connection 204

Figure 88: SHIELD CONNECTION CLAMP 14 mm 205

Figure 89: Product identification..... 208

Blank page